



КАТАЛОГ

По вопросам продаж и поддержки обращайтесь:

Алматы (7273)495-231
Ангарск (3955)60-70-56
Архангельск (8182)63-90-72
Астрахань (8512)99-46-04
Барнаул (3852)73-04-60
Белгород (4722)40-23-64
Благовещенск (4162)22-76-07
Брянск (4832)59-03-52
Владивосток (423)249-28-31
Владикавказ (8672)28-90-48
Владимир (4922)49-43-18
Волгоград (844)278-03-48
Вологда (8172)26-4159
Воронеж (473)204-51-73
Екатеринбург (343)384-55-89
Иваново (4932)77-34-06
Ижевск (3412)26-03-58
Иркутск (395)279-98-46
Казань (843)206-01-48

Калининград (4012)72-03-81
Калуга (4842)92-23-67
Кемерово (3842)65-04-62
Киров (8332)68-02-04
Коломна (4966)23-41-49
Кострома (4942)77-07-48
Краснодар (861)203-40-90
Красноярск (391)204-63-61
Курск (4712)77-13-04
Курган (3522)50-90-47
Липецк (4742)52-20-81
Магнитогорск (3519)55-03-13
Москва (495)268-04-70
Мурманск (8152)59-64-93
Набережные Челны (8552)20-53-41
Нижний Новгород (831)429-08-12
Новокузнецк (3843)20-46-81
Ноябрьск (3496)41-32-12
Новосибирск (383)227-86-73

Омск (3812)21-46-40
Орел (4862)44-53-42
Оренбург (3532)37-68-04
Пенза (8412)22-31-16
Петрозаводск (8142)55-98-37
Псков (8112)59-10-37
Пермь (342)205-81-47
Ростов-на-Дону (863)308-18-15
Рязань (4912)46-61-64
Самара (846)206-03-16
Саранск (8342)22-96-24
Санкт-Петербург (812)309-46-40
Саратов (845)249-38-78
Севастополь (8692)22-31-93
Симферополь (3652)67-13-56
Смоленск (4812)29-41-54
Сочи (862)225-72-31
Ставрополь (8652)20-65-13
Сургут (3462)77-98-35

Сыктывкар (8212)25-95-17
Тамбов (4752)50-40-97
Тверь (4822)63-31-35
Тольятти (8482)63-91-07
Томск (3822)98-41-53
Тула (4872)33-79-87
Тюмень (3452)66-21-18
Ульяновск (8422)24-23-59
Улан-Удэ (3012)59-97-51
Уфа (347)229-48-12
Хабаровск (4212)92-98-04
Чебоксары (8352)28-53-07
Челябинск (351)202-03-61
Череповец (8202)49-02-64
Чита (3022)38-34-83
Якутск (4112)23-90-97
Ярославль (4852)69-52-93

Россия +7(495)268-04-70

Казахстан +7(7172)727-132

Киргизия +996(312)96-26-47

Адрес: <https://fast.nt-rt.ru/> || эл.почта: ftj@nt-rt.ru

WILD

69T1

RV.2-1-2024

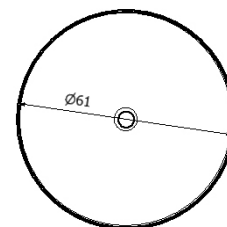
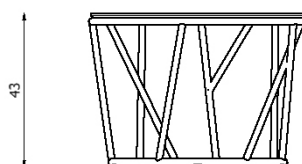
Descrizione / Description**Misure / Quotes****Caratteristiche / Characteristics**

Tavolino in alluminio verniciato / Small table in painted aluminium

Design / Design	Robby Cantarutti & Partners 2019	
Dimensioni / Dimensions	Ø 61 x 43 h	
Esterno / Outdoor	Sì / Yes	
Struttura / Structure	Alluminio estruso / Extruded aluminium	
Piedini / Caps	Polipropilene ed elastomero termoplastico / Polypropylene and thermoplastics elastomer	
Finitura / Paint finishes	Verniciatura polveri poliestere o poliuretatiche / Paint finish with polyester or polyurethane powders	
Impilabilità / Stackability	No	
Viterie assemblaggio / Assembly screws	Acciaio inox / Stainless steel	
Peso netto singolo pezzo / Net weight	3,8 kg	
Pezzi per scatola / Units per package	1 assemblato / 1 assembled	
Dimensione e volume imballo / Packaging dimension and volume	67 x 60 x 62 cm	0.249 m ³
Peso lordo imballo / Packaging Brutto weight	10 kg	
Garanzia / Quality guarantee	2 anni / 2 years	

WILD

69T2

RV.2-1-2024

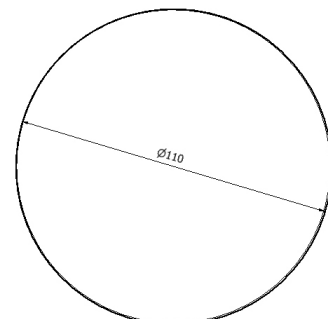
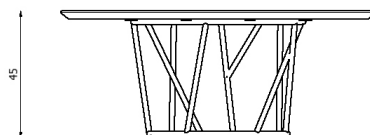
Descrizione / Description**Misure / Quotes****Caratteristiche / Characteristics**

Tavolo basso tondo in alluminio verniciato / Round low table in painted aluminium

Design / Design	Robby Cantarutti & Partners 2019
Dimensioni / Dimensions	Ø 110 x 45 h
Esterno / Outdoor	Si / Yes
Struttura / Structure	Alluminio estruso / Extruded aluminium
Piedini / Caps	Polipropilene ed elastomero termoplastico / Polypropylene and thermoplastics elastomer
Finitura / Paint finishes	Verniciatura polveri poliestere o poliuretatiche / Paint finish with polyester or polyurethane powders
Impilabilità / Stackability	No
Viterie assemblaggio / Assembly screws	Acciaio inox / Stainless steel
Peso netto singolo pezzo / Net weight	15 kg
Pezzi per scatola / Units per package	1 assemblato / 1 assembled
Dimensione e volume imballo / Packaging dimension and volume	131 x 131 x 45 cm 0.772 m ³
Peso lordo imballo / Packaging Brutto weight	31 kg
Garanzia / Quality guarantee	2 anni / 2 years

WILD

69T2S

RV.2-1-2024

Descrizione / Description

Misure / Quotes

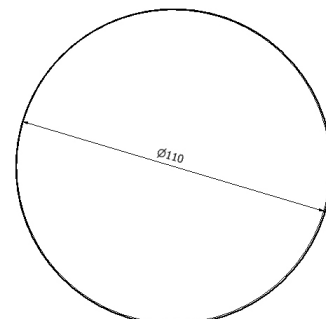
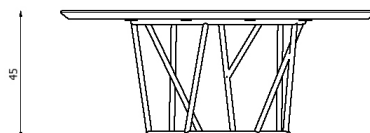

Caratteristiche / Characteristics

Tavolo basso tondo in alluminio verniciato con piano in alluminio puntinato / Round low table in painted aluminium with top in speckled aluminium

Design / Design

Robby Cantarutti & Partners | 2019

Dimensioni / Dimensions

Ø 110 x 45 h

Esterno / Outdoor

Sì / Yes

Struttura / Structure

Alluminio estruso / Extruded aluminium

Piedini / Caps

Polipropilene ed elastomero termoplastico / Polypropylene and thermoplastics elastomer

Finitura / Paint finishes

Verniciatura polveri poliestere o poliuretaniche ed effetto puntinato / Paint finish with polyester or polyurethane powders and speckled aluminium effect

Impilabilità / Stackability

No

Viterie assemblaggio / Assembly screws

Acciaio inox / Stainless steel

Peso netto singolo pezzo / Net weight

15 kg

Pezzi per scatola / Units per package

1 assemblato / 1 assembled

Dimensione e volume imballo / Packaging dimension and volume

131 x 131 x 45 cm 0.772 m³

Peso lordo imballo / Packaging Brutto weight

31 kg

Garanzia / Quality guarantee

2 anni / 2 years

WILD

69T5

RV.2-1-2024

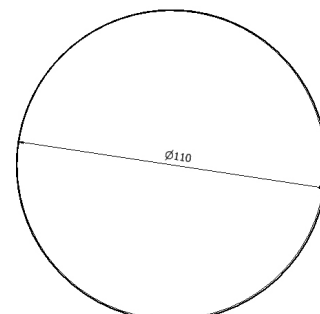
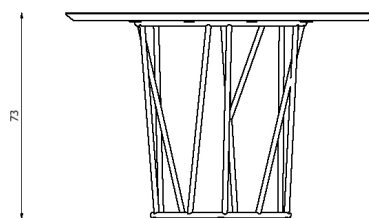
Descrizione / Description**Misure / Quotes****Caratteristiche / Characteristics**

Tavolo tondo in alluminio verniciato / Round table in painted aluminium

Design / Design	Robby Cantarutti & Partners 2019	
Dimensioni / Dimensions	Ø 110 x 73 h	
Esterno / Outdoor	Sì / Yes	
Struttura / Structure	Alluminio estruso / Extruded aluminium	
Piedini / Caps	Polipropilene ed elastomero termoplastico / Polypropylene and thermoplastics elastomer	
Finitura / Paint finishes	Verniciatura polveri poliestere o poliuretaniche / Paint finish with polyester or polyurethane powders	
Impilabilità / Stackability	No	
Viterie assemblaggio / Assembly screws	Acciaio inox / Stainless steel	
Peso netto singolo pezzo / Net weight	16 kg	
Pezzi per scatola / Units per package	1 assemblato / 1 assembled	
Dimensione e volume imballo / Packaging dimension and volume	131 x 131 x 77 cm	1,321 m ³
Peso lordo imballo / Packaging Brutto weight	33 kg	
Garanzia / Quality guarantee	2 anni / 2 years	

WILD

69T5S

RV.2-1-2024

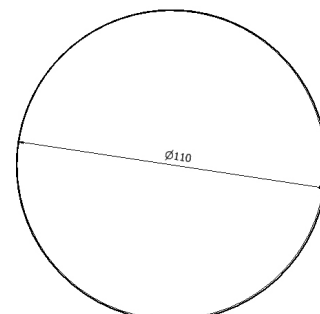
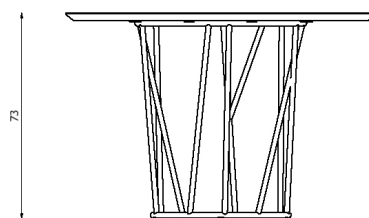
Descrizione / Description**Misure / Quotes****Caratteristiche / Characteristics**

Tavolo tondo in alluminio verniciato con piano in alluminio puntinato / Round table in painted aluminium with top in speckled aluminium

Design / Design

Robby Cantarutti & Partners | 2019

Dimensioni / Dimensions

Ø 110 x 73 h

Esterno / Outdoor

Sì / Yes

Struttura / Structure

Alluminio estruso / Extruded aluminium

Piedini / Caps

Polipropilene ed elastomero termoplastico / Polypropylene and thermoplastics elastomer

Finitura / Paint finishes

Verniciatura polveri poliestere o poliuretaniche ed effetto puntinato / Paint finish with polyester or polyurethane powders and speckled aluminium effect

Impilabilità / Stackability

No

Viterie assemblaggio / Assembly screws

Acciaio inox / Stainless steel

Peso netto singolo pezzo / Net weight

16 kg

Pezzi per scatola / Units per package

1 assemblato / 1 assembled

Dimensione e volume imballo / Packaging dimension and volume

131 x 131 x 77 cm 1,321 m³

Peso lordo imballo / Packaging Brutto weight

33 kg

Garanzia / Quality guarantee

2 anni / 2 years

WILD

69T8G

RV.2-1-2024

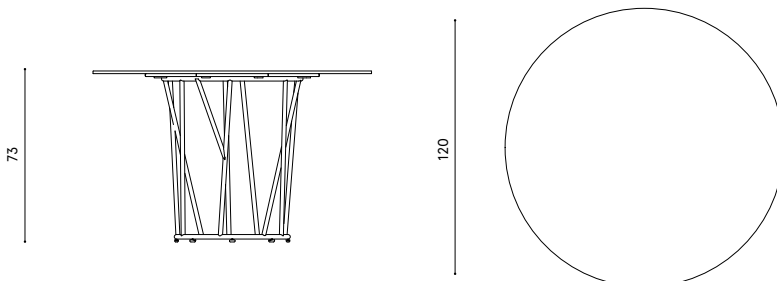
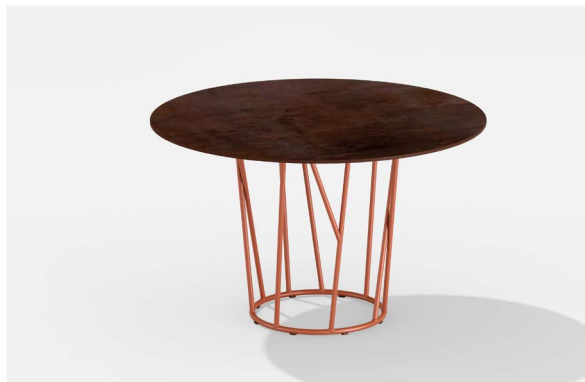
Descrizione / Description**Misure / Quotes****Caratteristiche / Characteristics**

Tavolo tondo in alluminio verniciato con piano in gres porcellanato (sp. 12 mm) / Round table in painted aluminium with top in porcelain stoneware (th. mm 12)

Design / Design

Robby Cantarutti & Partners | 2023

Dimensioni / Dimensions

Ø 120 x 73 h

Esterno / Outdoor

Sì / Yes

Struttura / Structure

Alluminio estruso e gres porcellanato / Extruded aluminium and porcelain stoneware

Piedini / Caps

Polipropilene ed elastomero termoplastico / Polypropylene and thermoplastics elastomer

Finitura / Paint finishes

Verniciatura polveri poliestere o poliuretaniche / Paint finish with polyester or polyurethane powders

Impilabilità / Stackability

No

Viterie assemblaggio / Assembly screws

Acciaio inox / Stainless steel

Peso netto singolo pezzo / Net weight

39 kg

Pezzi per scatola / Units per package

1 assemblato / 1 assembled

Dimensione e volume imballo / Packaging dimension and volume131 x 131 x 77 cm 1,321 m³**Peso lordo imballo / Packaging Brutto weight**

51 kg

Garanzia / Quality guarantee

2 anni / 2 years

WILD

69T6

RV.2-1-2024

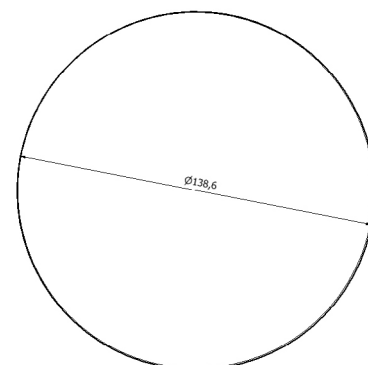
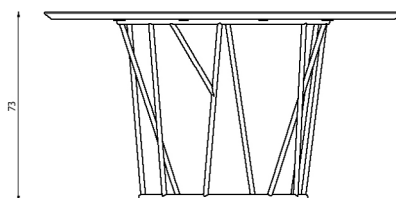
Descrizione / Description**Misure / Quotes****Caratteristiche / Characteristics**

Tavolo tondo in alluminio verniciato / Round table in painted aluminium

Design / Design

Robby Cantarutti & Partners | 2019

Dimensioni / Dimensions

Ø 138 x 73 h

Esterno / Outdoor

Sì / Yes

Struttura / Structure

Alluminio estruso / Extruded aluminium

Piedini / Caps

Polipropilene ed elastomero termoplastico / Polypropylene and thermoplastics elastomer

Finitura / Paint finishes

Verniciatura polveri poliestere o poliuretaniche / Paint finish with polyester or polyurethane powders

Impilabilità / Stackability

No

Viterie assemblaggio / Assembly screws

Acciaio inox / Stainless steel

Peso netto singolo pezzo / Net weight

22,5 kg

Pezzi per scatola / Units per package

1 assemblato / 1 assembled

Dimensione e volume imballo / Packaging dimension and volume

148 x 148 x 82 cm 1,796 m³

Peso lordo imballo / Packaging Brutto weight

40 kg

Garanzia / Quality guarantee

2 anni / 2 years

WILD

69T6S

RV.2-1-2024

Descrizione / Description

Misure / Quotes

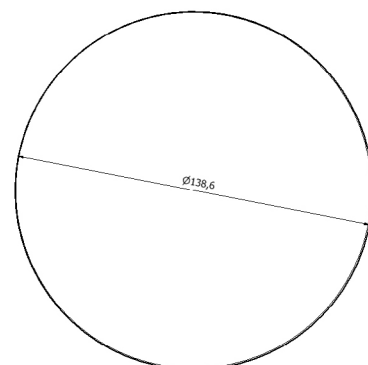
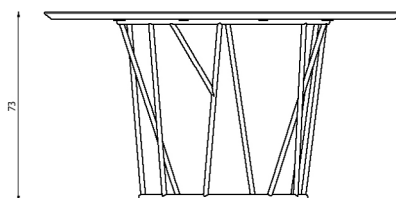

Caratteristiche / Characteristics

Tavolo tondo in alluminio verniciato con piano in alluminio puntinato / Round table in painted aluminium with top in speckled aluminium

Design / Design

Robby Cantarutti & Partners | 2019

Dimensioni / Dimensions

Ø 138 x 73 h

Esterno / Outdoor

Sì / Yes

Struttura / Structure

Alluminio estruso / Extruded aluminium

Piedini / Caps

Polipropilene ed elastomero termoplastico / Polypropylene and thermoplastics elastomer

Finitura / Paint finishes

Verniciatura polveri poliestere o poliuretaniche ed effetto puntinato / Paint finish with polyester or polyurethane powders and speckled aluminium effect

Impilabilità / Stackability

No

Viterie assemblaggio / Assembly screws

Acciaio inox / Stainless steel

Peso netto singolo pezzo / Net weight

22,5 kg

Pezzi per scatola / Units per package

1 assemblato / 1 assembled

Dimensione e volume imballo / Packaging dimension and volume

148 x 148 x 82 cm 1,796 m³

Peso lordo imballo / Packaging Brutto weight

40 kg

Garanzia / Quality guarantee

2 anni / 2 years

WILD

69T9G

RV.2-1-2024

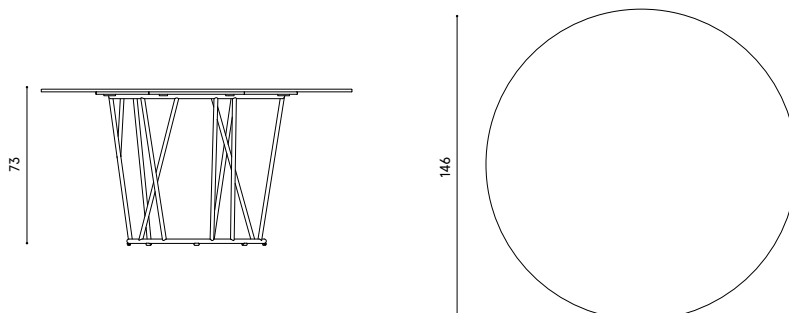
Descrizione / Description**Misure / Quotes****Caratteristiche / Characteristics**

Tavolo tondo in alluminio verniciato con piano in gres porcellanato (sp. 12 mm) / Round table in painted aluminium with top in porcelain stoneware (th. mm 12)

Design / Design	Robby Cantarutti & Partners 2019
Dimensioni / Dimensions	Ø 146 x 73 h
Esterno / Outdoor	Sì / Yes
Struttura / Structure	Alluminio estruso e gres porcellanato / Extruded aluminium and porcelain stoneware
Piedini / Caps	Polipropilene ed elastomero termoplastico / Polypropylene and thermoplastics elastomer
Finitura / Paint finishes	Verniciatura polveri poliestere o poliuretaniche / Paint finish with polyester or polyurethane powders
Impilabilità / Stackability	No
Viterie assemblaggio / Assembly screws	Acciaio inox / Stainless steel
Peso netto singolo pezzo / Net weight	56 kg
Pezzi per scatola / Units per package	1 assemblato / 1 assembled
Dimensione e volume imballo / Packaging dimension and volume	148 x 148 x 82 cm 1,796 m ³
Peso lordo imballo / Packaging Brutto weight	69 kg
Garanzia / Quality guarantee	2 anni / 2 years

WILD

69T7

RV.2-1-2024

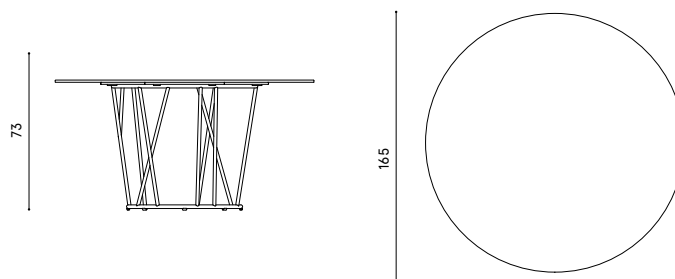
Descrizione / Description**Misure / Quotes****Caratteristiche / Characteristics**

Tavolo tondo in alluminio verniciato / Round table in painted aluminium

Design / Design	Robby Cantarutti & Partners 2019
Dimensioni / Dimensions	Ø 165 x 73 h
Esterno / Outdoor	Si / Yes
Struttura / Structure	Alluminio estruso / Extruded aluminium
Piedini / Caps	Polipropilene ed elastomero termoplastico / Polypropylene and thermoplastics elastomer
Finitura / Paint finishes	Verniciatura polveri poliestere o poliuretaniche / Paint finish with polyester or polyurethane powders
Impilabilità / Stackability	No
Viterie assemblaggio / Assembly screws	Acciaio inox / Stainless steel
Peso netto singolo pezzo / Net weight	22,5 kg
Pezzi per scatola / Units per package	1 assemblato / 1 assembled
Dimensione e volume imballo / Packaging dimension and volume	148 x 148 x 82 cm 1,796 m ³
Peso lordo imballo / Packaging Brutto weight	40 kg
Garanzia / Quality guarantee	2 anni / 2 years

WILD

69T7S

RV.2-1-2024

Descrizione / Description

Misure / Quotes

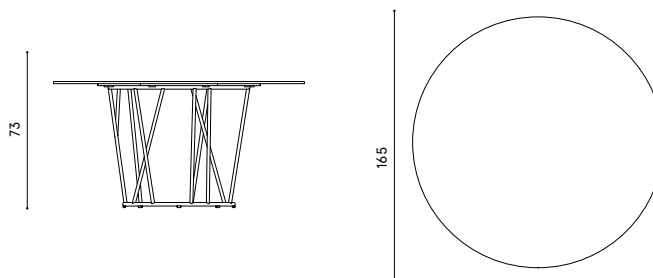

Caratteristiche / Characteristics

Tavolo tondo in alluminio verniciato con piano in alluminio puntinato / Round table in painted aluminium with top in speckled aluminium

Design / Design	Robby Cantarutti & Partners 2019
Dimensioni / Dimensions	Ø 165 x 73 h
Esterno / Outdoor	Si / Yes
Struttura / Structure	Alluminio estruso / Extruded aluminium
Piedini / Caps	Polipropilene ed elastomero termoplastico / Polypropylene and thermoplastics elastomer
Finitura / Paint finishes	Verniciatura polveri poliestere o poliuretaniche ed effetto puntinato / Paint finish with polyester or polyurethane powders and speckled aluminium effect
Impilabilità / Stackability	No
Viterie assemblaggio / Assembly screws	Acciaio inox / Stainless steel
Peso netto singolo pezzo / Net weight	22,5 kg
Pezzi per scatola / Units per package	1 assemblato / 1 assembled
Dimensione e volume imballo / Packaging dimension and volume	148 x 148 x 82 cm 1,796 m ³
Peso lordo imballo / Packaging Brutto weight	40 kg
Garanzia / Quality guarantee	2 anni / 2 years

WILD

69P1

RV.2-1-2024

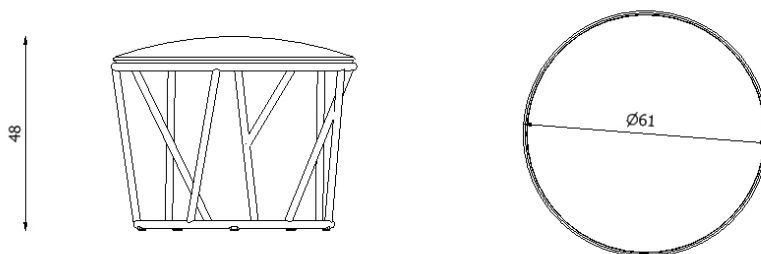
Descrizione / Description**Misure / Quotes****Caratteristiche / Characteristics**

Pouf in alluminio verniciato con cuscino removibile / Pouf in painted aluminium with removable cushion

Design / Design

Robby Cantarutti & Partners | 2019

Dimensioni / Dimensions

Ø 61 x 48 h

Esterno / Outdoor

Sì / Yes

Struttura / Structure

Alluminio estruso / Extruded aluminium

Piedini / Caps

Polipropilene ed elastomero termoplastico / Polypropylene and thermoplastics elastomer

Finitura / Paint finishes

Verniciatura polveri poliestere o poliuretaniche / Paint finish with polyester or polyurethane powders

Impilabilità / Stackability

No

Viterie assemblaggio / Assembly screws

Acciaio inox / Stainless steel

Peso netto singolo pezzo / Net weight

6 kg

Pezzi per scatola / Units per package

1 assemblato / 1 assembled

Dimensione e volume imballo / Packaging dimension and volume67 x 60 x 62 cm 0,249 m³**Peso lordo imballo / Packaging Brutto weight**

12 kg

Garanzia / Quality guarantee

2 anni / 2 years

WILD

69P2

RV.2-1-2024

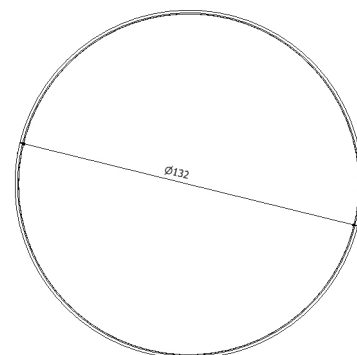
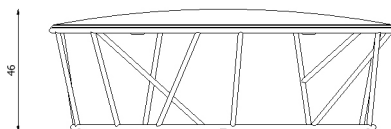
Descrizione / Description**Misure / Quotes****Caratteristiche / Characteristics**

Pouf in alluminio verniciato con cuscino removibile / Pouf in painted aluminium with removable cushion

Design / Design

Robby Cantarutti & Partners | 2019

Dimensioni / Dimensions

Ø 132 x 46 h

Esterno / Outdoor

Sì / Yes

Struttura / Structure

Alluminio estruso / Extruded aluminium

Piedini / Caps

Polipropilene ed elastomero termoplastico / Polypropylene and thermoplastics elastomer

Finitura / Paint finishes

Verniciatura polveri poliestere o poliuretatiche / Paint finish with polyester or polyurethane powders

Impilabilità / Stackability

No

Viterie assemblaggio / Assembly screws

Acciaio inox / Stainless steel

Peso netto singolo pezzo / Net weight

26 kg

Pezzi per scatola / Units per package

1 assemblato / 1 assembled

Dimensione e volume imballo / Packaging dimension and volume148 x 148 x 55 cm 1,204 m³**Peso lordo imballo / Packaging Brutto weight**

39 kg

Garanzia / Quality guarantee

2 anni / 2 years

По вопросам продаж и поддержки обращайтесь:

Алматы (7273)495-231
Ангарск (3955)60-70-56
Архангельск (8182)63-90-72
Астрахань (8512)99-46-04
Барнаул (3852)73-04-60
Белгород (4722)40-23-64
Благовещенск (4162)22-76-07
Брянск (4832)59-03-52
Владивосток (423)249-28-31
Владикавказ (8672)28-90-48
Владимир (4922)49-43-18
Волгоград (844)278-03-48
Вологда (8172)26-4159
Воронеж (473)204-51-73
Екатеринбург (343)384-55-89
Иваново (4932)77-34-06
Ижевск (3412)26-03-58
Иркутск (395)279-98-46
Казань (843)206-01-48

Калининград (4012)72-03-81
Калуга (4842)92-23-67
Кемерово (3842)65-04-62
Киров (8332)68-02-04
Коломна (4966)23-41-49
Кострома (4942)77-07-48
Краснодар (861)203-40-90
Красноярск (391)204-63-61
Курск (4712)77-13-04
Курган (3522)50-90-47
Липецк (4742)52-20-81
Магнитогорск (3519)55-03-13
Москва (495)268-04-70
Мурманск (8152)59-64-93
Набережные Челны (8552)20-53-41
Нижний Новгород (831)429-08-12
Новокузнецк (3843)20-46-81
Ноябрьск (3496)41-32-12
Новосибирск (383)227-86-73

Омск (3812)21-46-40
Орел (4862)44-53-42
Оренбург (3532)37-68-04
Пенза (8412)22-31-16
Петрозаводск (8142)55-98-37
Псков (8112)59-10-37
Пермь (342)205-81-47
Ростов-на-Дону (863)308-18-15
Рязань (4912)46-61-64
Самара (846)206-03-16
Саранск (8342)22-96-24
Санкт-Петербург (812)309-46-40
Саратов (845)249-38-78
Севастополь (8692)22-31-93
Симферополь (3652)67-13-56
Смоленск (4812)29-41-54
Сочи (862)225-72-31
Ставрополь (8652)20-65-13
Сургут (3462)77-98-35

Сыктывкар (8212)25-95-17
Тамбов (4752)50-40-97
Тверь (4822)63-31-35
Тольятти (8482)63-91-07
Томск (3822)98-41-53
Тула (4872)33-79-87
Тюмень (3452)66-21-18
Ульяновск (8422)24-23-59
Улан-Удэ (3012)59-97-51
Уфа (347)229-48-12
Хабаровск (4212)92-98-04
Чебоксары (8352)28-53-07
Челябинск (351)202-03-61
Череповец (8202)49-02-64
Чита (3022)38-34-83
Якутск (4112)23-90-97
Ярославль (4852)69-52-93

Россия +7(495)268-04-70

Казахстан +7(7172)727-132

Киргизия +996(312)96-26-47

Адрес: <https://fast.nt-rt.ru/> || эл.почта: ftj@nt-rt.ru