

# SOLARIS

## КАТАЛОГ

По вопросам продаж и поддержки обращайтесь:

Алматы (7273)495-231  
Ангарск (3955)60-70-56  
Архангельск (8182)63-90-72  
Астрахань (8512)99-46-04  
Барнаул (3852)73-04-60  
Белгород (4722)40-23-64  
Благовещенск (4162)22-76-07  
Брянск (4832)59-03-52  
Владивосток (423)249-28-31  
Владикавказ (8672)28-90-48  
Владимир (4922)49-43-18  
Волгоград (844)278-03-48  
Вологда (8172)26-4159  
Воронеж (473)204-51-73  
Екатеринбург (343)384-55-89  
Иваново (4932)77-34-06  
Ижевск (3412)26-03-58  
Иркутск (395)279-98-46  
Казань (843)206-01-48

Калининград (4012)72-03-81  
Калуга (4842)92-23-67  
Кемерово (3842)65-04-62  
Киров (8332)68-02-04  
Коломна (4966)23-41-49  
Кострома (4942)77-07-48  
Краснодар (861)203-40-90  
Красноярск (391)204-63-61  
Курск (4712)77-13-04  
Курган (3522)50-90-47  
Липецк (4742)52-20-81  
Магнитогорск (3519)55-03-13  
Москва (495)268-04-70  
Мурманск (8152)59-64-93  
Набережные Челны (8552)20-53-41  
Нижний Новгород (831)429-08-12  
Новокузнецк (3843)20-46-81  
Ноябрьск (3496)41-32-12  
Новосибирск (383)227-86-73

Омск (3812)21-46-40  
Орел (4862)44-53-42  
Оренбург (3532)37-68-04  
Пенза (8412)22-31-16  
Петрозаводск (8142)55-98-37  
Псков (8112)59-10-37  
Пермь (342)205-81-47  
Ростов-на-Дону (863)308-18-15  
Рязань (4912)46-61-64  
Самара (846)206-03-16  
Саранск (8342)22-96-24  
Санкт-Петербург (812)309-46-40  
Саратов (845)249-38-78  
Севастополь (8692)22-31-93  
Симферополь (3652)67-13-56  
Смоленск (4812)29-41-54  
Сочи (862)225-72-31  
Ставрополь (8652)20-65-13  
Сургут (3462)77-98-35

Сыктывкар (8212)25-95-17  
Тамбов (4752)50-40-97  
Тверь (4822)63-31-35  
Тольятти (8482)63-91-07  
Томск (3822)98-41-53  
Тула (4872)33-79-87  
Тюмень (3452)66-21-18  
Ульяновск (8422)24-23-59  
Улан-Удэ (3012)59-97-51  
Уфа (347)229-48-12  
Хабаровск (4212)92-98-04  
Чебоксары (8352)28-53-07  
Челябинск (351)202-03-61  
Череповец (8202)49-02-64  
Чита (3022)38-34-83  
Якутск (4112)23-90-97  
Ярославль (4852)69-52-93

Россия +7(495)268-04-70

Казахстан +7(7172)727-132

Киргизия +996(312)96-26-47

Адрес: <https://fast.nt-rt.ru/> || эл.почта: [ftj@nt-rt.ru](mailto:ftj@nt-rt.ru)

# Solaris

# 7301

RV.1-10-2022

## Descrizione / Description

## Misure / Quotes

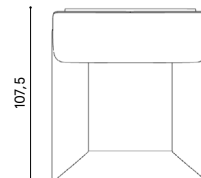
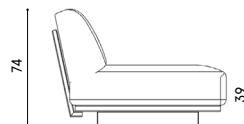
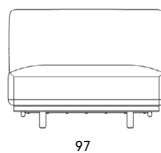

## Caratteristiche / Characteristics

Poltrona in alluminio verniciato / Armchair in painted aluminium

### Design / Design

Alberto Lievore | 2022

### Dimensioni / Dimensions

107,5 x 97 x 74 h

### Esterno / Outdoor

Si / Yes

### Struttura / Structure

Alluminio estruso / Extruded aluminium

### Elementi plastici / Plastic elements

Polipropilene e polietilene / Polypropylene and polyethylene

### Finitura / Paint finishes

Verniciatura polveri poliestere o poliuretatiche / Paint finish with polyester or polyurethane powders

### Impilabilità / Stackability

Si / Yes

### Viterie assemblaggio / Assembly screws

Acciaio inox / Stainless steel

### Peso netto singolo pezzo / Net weight

22 kg

### Pezzi per scatola / Units per package

1 assemblati / 1 assembled

### Dimensione e volume imballo / Packaging dimension and volume

125 x 115 x 77 cm 1.114 m<sup>3</sup>

### Peso lordo imballo / Gross weight package

29 kg

### Garanzia / Quality guarantee

2 anni / 2 years

## Descrizione / Description

## Misure / Quotes

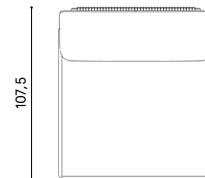
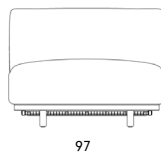

## Caratteristiche / Characteristics

Poltrona in alluminio verniciato con intreccio / Armchair in painted aluminium with woven pattern

## Design / Design

Alberto Lievore | 2022

## Dimensioni / Dimensions

107,5 x 97 x 74 h

## Esterno / Outdoor

Si / Yes

## Struttura / Structure

Alluminio estruso / Extruded aluminium

## Corda / Rope

Corda 100% polipropilene tinto in massa / 100% dyed in the mass polypropylene rope

## Elementi plastici / Plastic elements

Polipropilene e polietilene / Polypropylene and polyethylene

## Finitura / Paint finishes

Verniciatura polveri poliestere o poliuretaniche/ Paint finish with polyester or polyurethane powders

## Impilabilità / Stackability

Si / Yes

## Viterie assemblaggio / Assembly screws

Acciaio inox / Stainless steel

## Peso netto singolo pezzo / Net weight

23 kg

## Pezzi per scatola / Units per package

1 assemblati / 1 assembled

## Dimensione e volume imballo / Packaging dimension and volume

125 x 115 x 77 cm 1.114 m<sup>3</sup>

## Peso lordo imballo / Gross weight package

30 kg

## Garanzia / Quality guarantee

2 anni / 2 years

# Solaris

# 7301BD

RV.1-10-2022

## Descrizione / Description

## Misure / Quotes

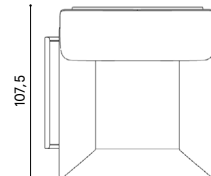
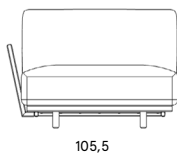

## Caratteristiche / Characteristics

Poltrona con bracciolo destro in alluminio verniciato / Armchair with right armrest in painted aluminium

## Design / Design

Alberto Lievore | 2022

## Dimensioni / Dimensions

107,5 x 105,5 x 74 h

## Esterno / Outdoor

Si / Yes

## Struttura / Structure

Alluminio estruso / Extruded aluminium

## Elementi plastici / Plastic elements

Polipropilene e polietilene / Polypropylene and polyethylene

## Finitura / Paint finishes

Verniciatura polveri poliestere o poliuretaniche / Paint finish with polyester or polyurethane powders

## Impilabilità / Stackability

Si / Yes

## Viterie assemblaggio / Assembly screws

Acciaio inox / Stainless steel

## Peso netto singolo pezzo / Net weight

23 kg

## Pezzi per scatola / Units per package

1 assemblati / 1 assembled

## Dimensione e volume imballo / Packaging dimension and volume

125 x 115 x 77 cm 1.114 m<sup>3</sup>

## Peso lordo imballo / Gross weight package

30,5 kg

## Garanzia / Quality guarantee

2 anni / 2 years

## Descrizione / Description

## Misure / Quotes

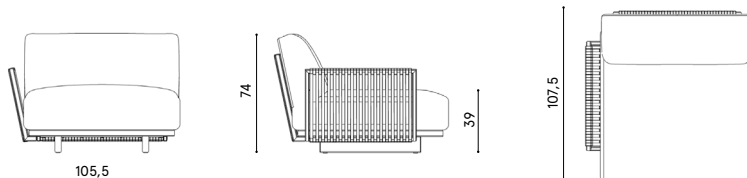

## Caratteristiche / Characteristics

Poltrona con bracciolo destro in alluminio verniciato con intreccio / Armchair with right armrest in painted aluminium with woven pattern

## Design / Design

Alberto Lievore | 2022

## Dimensioni / Dimensions

107,5 x 105,5 x 74 h

## Esterno / Outdoor

Si / Yes

## Struttura / Structure

Alluminio estruso / Extruded aluminium

## Corda / Rope

Corda 100% polipropilene tinto in massa / 100% dyed in the mass polypropylene rope

## Elementi plastici / Plastic elements

Polipropilene e polietilene / Polypropylene and polyethylene

## Finitura / Paint finishes

Verniciatura polveri poliestere o poliuretaniche/ Paint finish with polyester or polyurethane powders

## Impilabilità / Stackability

Si / Yes

## Viterie assemblaggio / Assembly screws

Acciaio inox / Stainless steel

## Peso netto singolo pezzo / Net weight

25 kg

## Pezzi per scatola / Units per package

1 assemblati / 1 assembled

## Dimensione e volume imballo / Packaging dimension and volume

125 x 115 x 77 cm 1.114 m<sup>3</sup>

## Peso lordo imballo / Gross weight package

32 kg

## Garanzia / Quality guarantee

2 anni / 2 years

# Solaris

# 7301BS

RV.1-10-2022

## Descrizione / Description

## Misure / Quotes

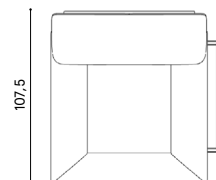
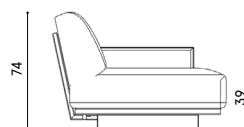
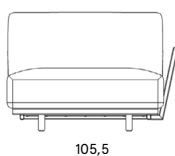

## Caratteristiche / Characteristics

Poltrona con bracciolo sinistro in alluminio verniciato / Armchair with left armrest in painted aluminium

## Design / Design

Alberto Lievore | 2022

## Dimensioni / Dimensions

107,5 x 105,5 x 74 h

## Esterno / Outdoor

Si / Yes

## Struttura / Structure

Alluminio estruso / Extruded aluminium

## Elementi plastici / Plastic elements

Polipropilene e polietilene / Polypropylene and polyethylene

## Finitura / Paint finishes

Verniciatura polveri poliestere o poliuretaniche / Paint finish with polyester or polyurethane powders

## Impilabilità / Stackability

Si / Yes

## Viterie assemblaggio / Assembly screws

Acciaio inox / Stainless steel

## Peso netto singolo pezzo / Net weight

23 kg

## Pezzi per scatola / Units per package

1 assemblati / 1 assembled

## Dimensione e volume imballo / Packaging dimension and volume

125 x 115 x 77 cm 1.114 m<sup>3</sup>

## Peso lordo imballo / Gross weight package

30,5 kg

## Garanzia / Quality guarantee

2 anni / 2 years

# Solaris

# 7311BS

RV.1-10-2022

## Descrizione / Description

## Misure / Quotes

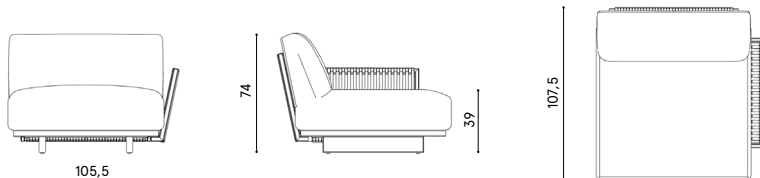

## Caratteristiche / Characteristics

Poltrona con bracciolo sinistro in alluminio verniciato con intreccio / Armchair with left armrest in painted aluminium with woven pattern

## Design / Design

Alberto Lievore | 2022

## Dimensioni / Dimensions

107,5 x 105,5 x 74 h

## Esterno / Outdoor

Si / Yes

## Struttura / Structure

Alluminio estruso / Extruded aluminium

## Corda / Rope

Corda 100% polipropilene tinto in massa / 100% dyed in the mass polypropylene rope

## Elementi plastici / Plastic elements

Polipropilene e polietilene / Polypropylene and polyethylene

## Finitura / Paint finishes

Verniciatura polveri poliestere o poliuretaniche/ Paint finish with polyester or polyurethane powders

## Impilabilità / Stackability

Si / Yes

## Viterie assemblaggio / Assembly screws

Acciaio inox / Stainless steel

## Peso netto singolo pezzo / Net weight

25 kg

## Pezzi per scatola / Units per package

1 assemblati / 1 assembled

## Dimensione e volume imballo / Packaging dimension and volume

125 x 115 x 77 cm 1.114 m<sup>3</sup>

## Peso lordo imballo / Gross weight package

32 kg

## Garanzia / Quality guarantee

2 anni / 2 years

# Solaris

# 7301B

RV.1-10-2022

## Descrizione / Description

## Misure / Quotes

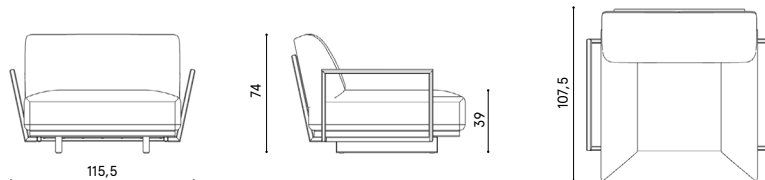

## Caratteristiche / Characteristics

Poltrona con braccioli in alluminio verniciato / Armchair with armrests in painted aluminium

## Design / Design

Alberto Lievore | 2022

## Dimensioni / Dimensions

107,5 x 115 x 74 h

## Esterno / Outdoor

Si / Yes

## Struttura / Structure

Alluminio estruso / Extruded aluminium

## Elementi plastici / Plastic elements

Polipropilene e polietilene / Polypropylene and polyethylene

## Finitura / Paint finishes

Verniciatura polveri poliestere o poliuretatiche / Paint finish with polyester or polyurethane powders

## Impilabilità / Stackability

Si / Yes

## Viterie assemblaggio / Assembly screws

Acciaio inox / Stainless steel

## Peso netto singolo pezzo / Net weight

24,3 kg

## Pezzi per scatola / Units per package

1 assemblati / 1 assembled

## Dimensione e volume imballo / Packaging dimension and volume

125 x 115 x 77 cm 1.114 m<sup>3</sup>

## Peso lordo imballo / Gross weight package

31,6 kg

## Garanzia / Quality guarantee

2 anni / 2 years



# Solaris

# 7311B

RV.1-10-2022

## Descrizione / Description

## Misure / Quotes

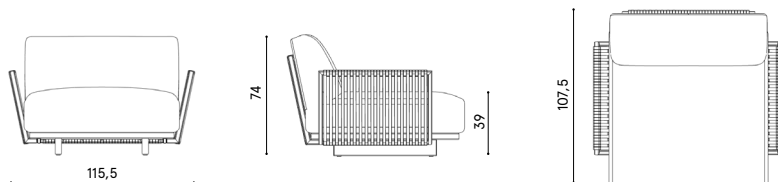

## Caratteristiche / Characteristics

Poltrona con braccioli in alluminio verniciato con intreccio / Armchair with armrests in painted aluminium with woven pattern

## Design / Design

Alberto Lievore | 2022

## Dimensioni / Dimensions

107,5 x 115 x 74 h

## Esterno / Outdoor

Si / Yes

## Struttura / Structure

Alluminio estruso / Extruded aluminium

## Corda / Rope

Corda 100% polipropilene tinto in massa / 100% dyed in the mass polypropylene rope

## Elementi plastici / Plastic elements

Polipropilene e polietilene / Polypropylene and polyethylene

## Finitura / Paint finishes

Verniciatura polveri poliestere o poliuretaniche / Paint finish with polyester or polyurethane powders

## Impilabilità / Stackability

Si / Yes

## Viterie assemblaggio / Assembly screws

Acciaio inox / Stainless steel

## Peso netto singolo pezzo / Net weight

26,8 kg

## Pezzi per scatola / Units per package

1 assemblati / 1 assembled

## Dimensione e volume imballo / Packaging dimension and volume

125 x 115 x 77 cm 1.114 m<sup>3</sup>

## Peso lordo imballo / Gross weight package

34 kg

## Garanzia / Quality guarantee

2 anni / 2 years

# Solaris

# 7301S

RV.1-10-2022

## Descrizione / Description

## Misure / Quotes

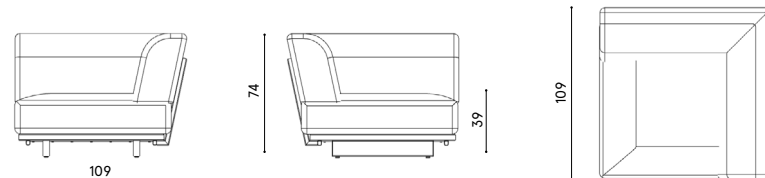

## Caratteristiche / Characteristics

Modulo ad angolo in alluminio verniciato / Corner module in painted aluminium

### Design / Design

Alberto Lievore | 2022

### Dimensioni / Dimensions

109 x 107,5 x 74 h

### Esterno / Outdoor

Si / Yes

### Struttura / Structure

Alluminio estruso / Extruded aluminium

### Elementi plastici / Plastic elements

Polipropilene e polietilene / Polypropylene and polyethylene

### Finitura / Paint finishes

Verniciatura polveri poliestere o poliuretaniche / Paint finish with polyester or polyurethane powders

### Impilabilità / Stackability

Si / Yes

### Viterie assemblaggio / Assembly screws

Acciaio inox / Stainless steel

### Peso netto singolo pezzo / Net weight

26,5 kg

### Pezzi per scatola / Units per package

1 assemblati / 1 assembled

### Dimensione e volume imballo / Packaging dimension and volume

125 x 115 x 77 cm 1.114 m<sup>3</sup>

### Peso lordo imballo / Gross weight package

34 kg

### Garanzia / Quality guarantee

2 anni / 2 years

## Descrizione / Description

## Misure / Quotes

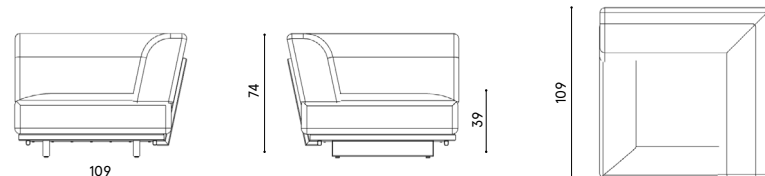

## Caratteristiche / Characteristics

Modulo ad angolo in alluminio verniciato con intreccio / Corner module in painted aluminium with woven pattern

## Design / Design

Alberto Lievore | 2022

## Dimensioni / Dimensions

109 x 107,5 x 74 h

## Esterno / Outdoor

Si / Yes

## Struttura / Structure

Alluminio estruso / Extruded aluminium

## Corda / Rope

Corda 100% polipropilene tinto in massa / 100% dyed in the mass polypropylene rope

## Elementi plastici / Plastic elements

Polipropilene e polietilene / Polypropylene and polyethylene

## Finitura / Paint finishes

Verniciatura polveri poliestere o poliuretaniche/ Paint finish with polyester or polyurethane powders

## Impilabilità / Stackability

Si / Yes

## Viterie assemblaggio / Assembly screws

Acciaio inox / Stainless steel

## Peso netto singolo pezzo / Net weight

28,5 kg

## Pezzi per scatola / Units per package

1 assemblati / 1 assembled

## Dimensione e volume imballo / Packaging dimension and volume

125 x 115 x 77 cm 1.114 m<sup>3</sup>

## Peso lordo imballo / Gross weight package

35,7 kg

## Garanzia / Quality guarantee

2 anni / 2 years

# Solaris

# 7302

RV.1-10-2022

## Descrizione / Description

## Misure / Quotes



## Caratteristiche / Characteristics

Dormeuse in alluminio verniciato / Dormeuse in painted aluminium

### Design / Design

Alberto Lievore | 2022

### Dimensioni / Dimensions

165 x 97 x 74 h

### Esterno / Outdoor

Si / Yes

### Struttura / Structure

Alluminio estruso / Extruded aluminium

### Elementi plastici / Plastic elements

Polipropilene e polietilene / Polypropylene and polyethylene

### Finitura / Paint finishes

Verniciatura polveri poliestere o poliuretatiche / Paint finish with polyester or polyurethane powders

### Impilabilità / Stackability

Si / Yes

### Viterie assemblaggio / Assembly screws

Acciaio inox / Stainless steel

### Peso netto singolo pezzo / Net weight

33 kg

### Pezzi per scatola / Units per package

1 assemblati / 1 assembled

### Dimensione e volume imballo / Packaging dimension and volume

173 x 125 x 77 cm 1.675 m<sup>3</sup>

### Peso lordo imballo / Gross weight package

43 kg

### Garanzia / Quality guarantee

2 anni / 2 years

## Descrizione / Description

## Misure / Quotes

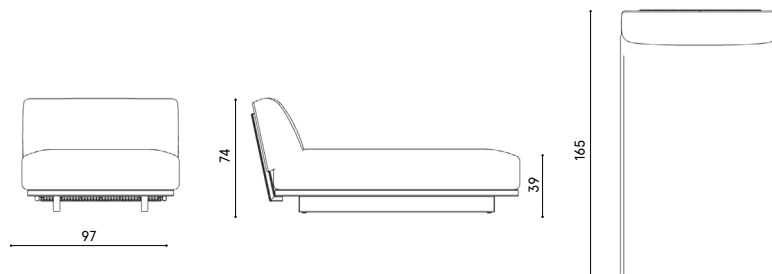

## Caratteristiche / Characteristics

Dormeuse in alluminio verniciato con intreccio / Dormeuse in painted aluminium with woven pattern

## Design / Design

Alberto Lievore | 2022

## Dimensioni / Dimensions

165 x 97 x 74 h

## Esterno / Outdoor

Si / Yes

## Struttura / Structure

Alluminio estruso / Extruded aluminium

## Corda / Rope

Corda 100% polipropilene tinto in massa / 100% dyed in the mass polypropylene rope

## Elementi plastici / Plastic elements

Polipropilene e polietilene / Polypropylene and polyethylene

## Finitura / Paint finishes

Verniciatura polveri poliestere o poliuretaniche/ Paint finish with polyester or polyurethane powders

## Impilabilità / Stackability

Si / Yes

## Viterie assemblaggio / Assembly screws

Acciaio inox / Stainless steel

## Peso netto singolo pezzo / Net weight

34 kg

## Pezzi per scatola / Units per package

1 assemblati / 1 assembled

## Dimensione e volume imballo / Packaging dimension and volume

173 x 125 x 77 cm 1.675 m<sup>3</sup>

## Peso lordo imballo / Gross weight package

44 kg

## Garanzia / Quality guarantee

2 anni / 2 years

# Solaris

# 7302BD

RV.1-10-2022

## Descrizione / Description

## Misure / Quotes



## Caratteristiche / Characteristics

Dormeuse con bracciolo destro in alluminio verniciato / Dormeuse with right armrest in painted aluminium

## Design / Design

Alberto Lievore | 2022

## Dimensioni / Dimensions

165 x 97 x 74 h

## Esterno / Outdoor

Si / Yes

## Struttura / Structure

Alluminio estruso / Extruded aluminium

## Elementi plastici / Plastic elements

Polipropilene e polietilene / Polypropylene and polyethylene

## Finitura / Paint finishes

Verniciatura polveri poliestere o poliuretaniche / Paint finish with polyester or polyurethane powders

## Impilabilità / Stackability

Si / Yes

## Viterie assemblaggio / Assembly screws

Acciaio inox / Stainless steel

## Peso netto singolo pezzo / Net weight

34 kg

## Pezzi per scatola / Units per package

1 assemblati / 1 assembled

## Dimensione e volume imballo / Packaging dimension and volume

173 x 125 x 77 cm 1.675 m<sup>3</sup>

## Peso lordo imballo / Gross weight package

44 kg

## Garanzia / Quality guarantee

2 anni / 2 years

# Solaris

# 7312BD

RV.1-10-2022

## Descrizione / Description

## Misure / Quotes

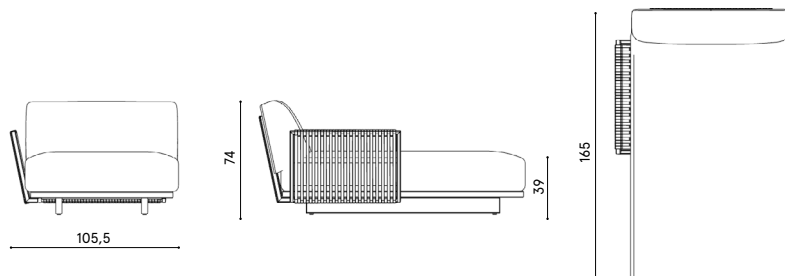

## Caratteristiche / Characteristics

Dormeuse con bracciolo destro in alluminio verniciato con intreccio / Dormeuse with right armrest in painted aluminium with woven pattern

## Design / Design

Alberto Lievore | 2022

## Dimensioni / Dimensions

165 x 105,5 x 74 h

## Esterno / Outdoor

Si / Yes

## Struttura / Structure

Alluminio estruso / Extruded aluminium

## Corda / Rope

Corda 100% polipropilene tinto in massa / 100% dyed in the mass polypropylene rope

## Elementi plastici / Plastic elements

Polipropilene e polietilene / Polypropylene and polyethylene

## Finitura / Paint finishes

Verniciatura polveri poliestere o poliuretaniche/ Paint finish with polyester or polyurethane powders

## Impilabilità / Stackability

Si / Yes

## Viterie assemblaggio / Assembly screws

Acciaio inox / Stainless steel

## Peso netto singolo pezzo / Net weight

36 kg

## Pezzi per scatola / Units per package

1 assemblati / 1 assembled

## Dimensione e volume imballo / Packaging dimension and volume

173 x 125 x 77 cm 1.675 m<sup>3</sup>

## Peso lordo imballo / Gross weight package

46 kg

## Garanzia / Quality guarantee

2 anni / 2 years

# Solaris

# 7302BS

RV.1-10-2022

## Descrizione / Description

## Misure / Quotes



## Caratteristiche / Characteristics

Dormeuse con bracciolo sinistro in alluminio verniciato / Dormeuse with left armrest in painted aluminium

## Design / Design

Alberto Lievore | 2022

## Dimensioni / Dimensions

165 x 105,5 x 74 h

## Esterno / Outdoor

Si / Yes

## Struttura / Structure

Alluminio estruso / Extruded aluminium

## Elementi plastici / Plastic elements

Polipropilene e polietilene / Polypropylene and polyethylene

## Finitura / Paint finishes

Verniciatura polveri poliestere o poliuretaniche / Paint finish with polyester or polyurethane powders

## Impilabilità / Stackability

Si / Yes

## Viterie assemblaggio / Assembly screws

Acciaio inox / Stainless steel

## Peso netto singolo pezzo / Net weight

34 kg

## Pezzi per scatola / Units per package

1 assemblati / 1 assembled

## Dimensione e volume imballo / Packaging dimension and volume

173 x 125 x 77 cm 1.675 m<sup>3</sup>

## Peso lordo imballo / Gross weight package

44 kg

## Garanzia / Quality guarantee

2 anni / 2 years



# Solaris

# 7312BS

RV.1-10-2022

## Descrizione / Description

## Misure / Quotes

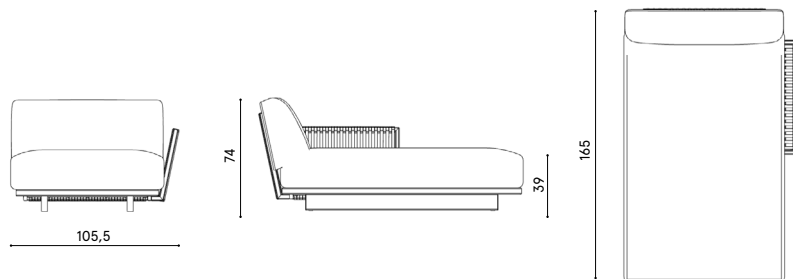

## Caratteristiche / Characteristics

Dormeuse con bracciolo sinistro in alluminio verniciato con intreccio / Dormeuse with left armrest in painted aluminium with woven pattern

## Design / Design

Alberto Lievore | 2022

## Dimensioni / Dimensions

165 x 105,5 x 74 h

## Esterno / Outdoor

Si / Yes

## Struttura / Structure

Alluminio estruso / Extruded aluminium

## Corda / Rope

Corda 100% polipropilene tinto in massa / 100% dyed in the mass polypropylene rope

## Elementi plastici / Plastic elements

Polipropilene e polietilene / Polypropylene and polyethylene

## Finitura / Paint finishes

Verniciatura polveri poliestere o poliuretaniche/ Paint finish with polyester or polyurethane powders

## Impilabilità / Stackability

Si / Yes

## Viterie assemblaggio / Assembly screws

Acciaio inox / Stainless steel

## Peso netto singolo pezzo / Net weight

36 kg

## Pezzi per scatola / Units per package

1 assemblati / 1 assembled

## Dimensione e volume imballo / Packaging dimension and volume

173 x 125 x 77 cm 1.675 m<sup>3</sup>

## Peso lordo imballo / Gross weight package

46 kg

## Garanzia / Quality guarantee

2 anni / 2 years

# Solaris

# 7302B

RV.1-10-2022

## Descrizione / Description

## Misure / Quotes



## Caratteristiche / Characteristics

Dormeuse con braccioli in alluminio verniciato / Dormeuse with armrests in painted aluminium

## Design / Design

Alberto Lievore | 2022

## Dimensioni / Dimensions

165 x 115 x 74 h

## Esterno / Outdoor

Si / Yes

## Struttura / Structure

Alluminio estruso / Extruded aluminium

## Elementi plastici / Plastic elements

Polipropilene e polietilene / Polypropylene and polyethylene

## Finitura / Paint finishes

Verniciatura polveri poliestere o poliuretaniche / Paint finish with polyester or polyurethane powders

## Impilabilità / Stackability

Si / Yes

## Viterie assemblaggio / Assembly screws

Acciaio inox / Stainless steel

## Peso netto singolo pezzo / Net weight

35 kg

## Pezzi per scatola / Units per package

1 assemblati / 1 assembled

## Dimensione e volume imballo / Packaging dimension and volume

173 x 125 x 77 cm 1.675 m<sup>3</sup>

## Peso lordo imballo / Gross weight package

45 kg

## Garanzia / Quality guarantee

2 anni / 2 years

# Solaris

# 7312B

RV.1-10-2022

## Descrizione / Description

## Misure / Quotes

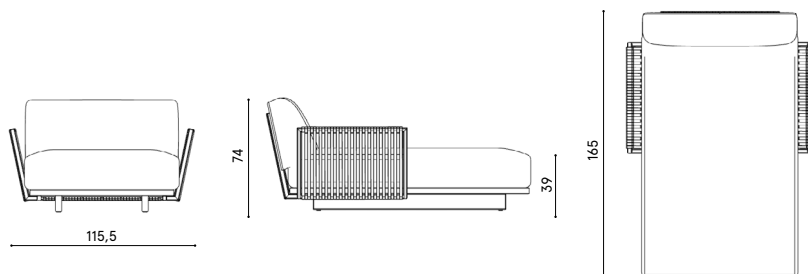

## Caratteristiche / Characteristics

Dormeuse con braccioli in alluminio verniciato con intreccio / Dormeuse with armrests in painted aluminium with woven pattern

## Design / Design

Alberto Lievore | 2022

## Dimensioni / Dimensions

165 x 115 x 74 h

## Esterno / Outdoor

Si / Yes

## Struttura / Structure

Alluminio estruso / Extruded aluminium

## Corda / Rope

Corda 100% polipropilene tinto in massa / 100% dyed in the mass polypropylene rope

## Elementi plastici / Plastic elements

Polipropilene e polietilene / Polypropylene and polyethylene

## Finitura / Paint finishes

Verniciatura polveri poliestere o poliuretaniche/ Paint finish with polyester or polyurethane powders

## Impilabilità / Stackability

Si / Yes

## Viterie assemblaggio / Assembly screws

Acciaio inox / Stainless steel

## Peso netto singolo pezzo / Net weight

38 kg

## Pezzi per scatola / Units per package

1 assemblati / 1 assembled

## Dimensione e volume imballo / Packaging dimension and volume

173 x 125 x 77 cm 1.675 m<sup>3</sup>

## Peso lordo imballo / Gross weight package

48 kg

## Garanzia / Quality guarantee

2 anni / 2 years

# Solaris

# 7303S

RV.1-10-2022

## Descrizione / Description

## Misure / Quotes

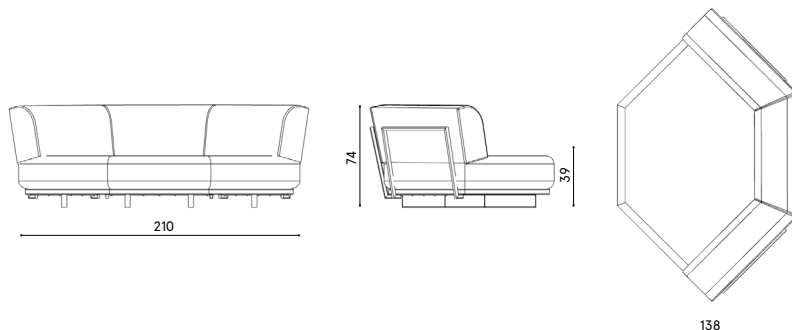

## Caratteristiche / Characteristics

Modulo esagonale in alluminio verniciato / Hexagonal module in painted aluminium

## Design / Design

Alberto Lievore | 2022

## Dimensioni / Dimensions

210 x 74 h

## Esterno / Outdoor

Si / Yes

## Struttura / Structure

Alluminio estruso / Extruded aluminium

## Elementi plastici / Plastic elements

Polipropilene e polietilene / Polypropylene and polyethylene

## Finitura / Paint finishes

Verniciatura polveri poliestere o poliuretaniche / Paint finish with polyester or polyurethane powders

## Impilabilità / Stackability

Si / Yes

## Viterie assemblaggio / Assembly screws

Acciaio inox / Stainless steel

## Peso netto singolo pezzo / Net weight

44,5 kg

## Pezzi per scatola / Units per package

1 assemblati / 1 assembled

## Dimensione e volume imballo / Packaging dimension and volume

223 x 147 x 77 cm 2.546 m<sup>3</sup>

## Peso lordo imballo / Gross weight package

59 kg

## Garanzia / Quality guarantee

2 anni / 2 years

## Descrizione / Description

## Misure / Quotes

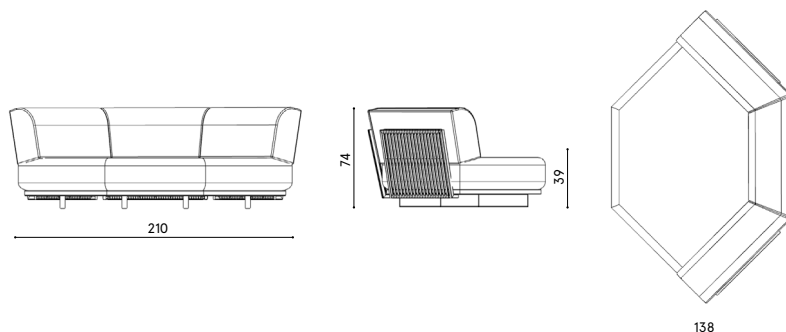

## Caratteristiche / Characteristics

Modulo esagonale in alluminio verniciato con intreccio / Hexagonal module in painted aluminium with woven pattern

## Design / Design

Alberto Lievore | 2022

## Dimensioni / Dimensions

210 x 74 h

## Esterno / Outdoor

Si / Yes

## Struttura / Structure

Alluminio estruso / Extruded aluminium

## Corda / Rope

Corda 100% polipropilene tinto in massa / 100% dyed in the mass polypropylene rope

## Elementi plastici / Plastic elements

Polipropilene e polietilene / Polypropylene and polyethylene

## Finitura / Paint finishes

Verniciatura polveri poliestere o poliuretaniche/ Paint finish with polyester or polyurethane powders

## Impilabilità / Stackability

Si / Yes

## Viterie assemblaggio / Assembly screws

Acciaio inox / Stainless steel

## Peso netto singolo pezzo / Net weight

47 kg

## Pezzi per scatola / Units per package

1 assemblati / 1 assembled

## Dimensione e volume imballo / Packaging dimension and volume

223 x 147 x 77 cm 2.546 m<sup>3</sup>

## Peso lordo imballo / Gross weight package

62 kg

## Garanzia / Quality guarantee

2 anni / 2 years

## Descrizione / Description

## Misure / Quotes



## Caratteristiche / Characteristics

Seduta/pouf in alluminio verniciato / Seat/pouf in painted aluminium

## Design / Design

Alberto Lievore | 2022

## Dimensioni / Dimensions

97 x 97 x 39 h

## Esterno / Outdoor

Sì / Yes

## Struttura / Structure

Alluminio estruso / Extruded aluminium

## Elementi plastici / Plastic elements

Polipropilene e polietilene / Polypropylene and polyethylene

## Finitura / Paint finishes

Verniciatura polveri poliestere o poliuretaniche / Paint finish with polyester or polyurethane powders

## Impilabilità / Stackability

Sì / Yes

## Viterie assemblaggio / Assembly screws

Acciaio inox / Stainless steel

## Peso netto singolo pezzo / Net weight

18 kg

## Pezzi per scatola / Units per package

1 assemblati / 1 assembled

## Dimensione e volume imballo / Packaging dimension and volume

125 x 115 x 43 cm 0.618 m<sup>3</sup>

## Peso lordo imballo / Gross weight package

25 kg

## Garanzia / Quality guarantee

2 anni / 2 years

## Descrizione / Description

## Misure / Quotes

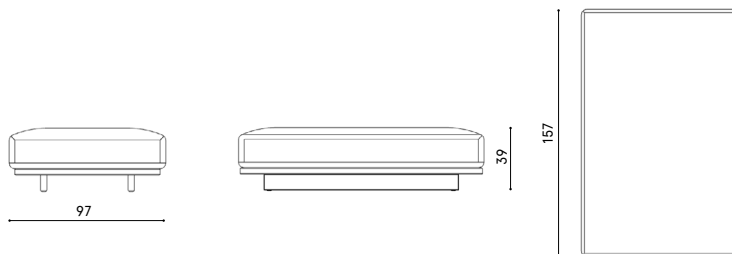

## Caratteristiche / Characteristics

Seduta/dormeuse in alluminio verniciato / Seat/dormeuse in painted aluminium

## Design / Design

Alberto Lievore | 2022

## Dimensioni / Dimensions

157 x 97 x 39 h

## Esterno / Outdoor

Sì / Yes

## Struttura / Structure

Alluminio estruso / Extruded aluminium

## Elementi plastici / Plastic elements

Polipropilene e polietilene / Polypropylene and polyethylene

## Finitura / Paint finishes

Verniciatura polveri poliestere o poliuretaniche / Paint finish with polyester or polyurethane powders

## Impilabilità / Stackability

Sì / Yes

## Viterie assemblaggio / Assembly screws

Acciaio inox / Stainless steel

## Peso netto singolo pezzo / Net weight

29 kg

## Pezzi per scatola / Units per package

1 assemblati / 1 assembled

## Dimensione e volume imballo / Packaging dimension and volume

173 x 125 x 43 cm 0.930 m<sup>3</sup>

## Peso lordo imballo / Gross weight package

39 kg

## Garanzia / Quality guarantee

2 anni / 2 years

## Descrizione / Description

## Misure / Quotes

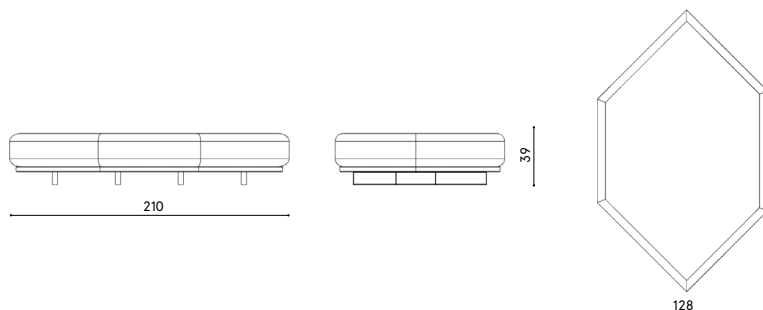

## Caratteristiche / Characteristics

Seduta/esagono in alluminio verniciato / Seat/hexagon in painted aluminium

## Design / Design

Alberto Lievore | 2022

## Dimensioni / Dimensions

210 x 128 x 39 h

## Esterno / Outdoor

Sì / Yes

## Struttura / Structure

Alluminio estruso / Extruded aluminium

## Elementi plastici / Plastic elements

Polipropilene e polietilene / Polypropylene and polyethylene

## Finitura / Paint finishes

Verniciatura polveri poliestere o poliuretaniche / Paint finish with polyester or polyurethane powders

## Impilabilità / Stackability

Sì / Yes

## Viterie assemblaggio / Assembly screws

Acciaio inox / Stainless steel

## Peso netto singolo pezzo / Net weight

33 kg

## Pezzi per scatola / Units per package

1 assemblati / 1 assembled

## Dimensione e volume imballo / Packaging dimension and volume

223 x 147 x 43 cm 1.413 m<sup>3</sup>

## Peso lordo imballo / Gross weight package

39 kg

## Garanzia / Quality guarantee

2 anni / 2 years



## Descrizione / Description

## Misure / Quotes

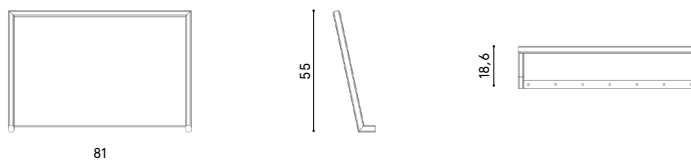
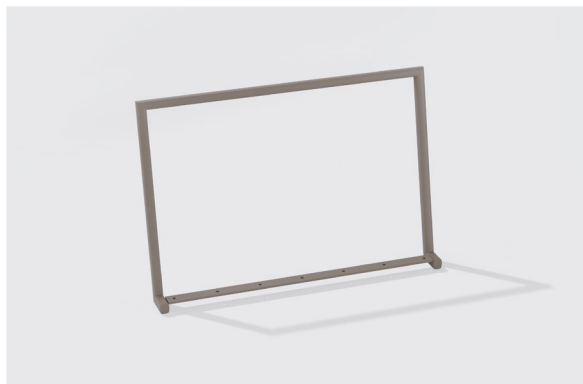

## Caratteristiche / Characteristics

Schienale in alluminio verniciato / Backrest in painted aluminium

## Design / Design

Alberto Lievore | 2022

## Dimensioni / Dimensions

81 x 19 x 55 h

## Esterno / Outdoor

Sì / Yes

## Struttura / Structure

Alluminio estruso / Extruded aluminium

## Elementi plastici / Plastic elements

/

## Finitura / Paint finishes

Verniciatura polveri poliestere o poliuretaniche / Paint finish with polyester or polyurethane powders

## Impilabilità / Stackability

Sì / Yes

## Viterie assemblaggio / Assembly screws

Acciaio inox / Stainless steel

## Peso netto singolo pezzo / Net weight

1,3 kg

## Pezzi per scatola / Units per package

1 assemblati / 1 assembled

## Dimensione e volume imballo / Packaging dimension and volume

84 x 84 x 14,5 cm 0,102 m<sup>3</sup>

## Peso lordo imballo / Gross weight package

3,6 kg

## Garanzia / Quality guarantee

2 anni / 2 years

## Accessori / Accessories



C7300CS



C7300CSC



C7301CSD



C7301CSS



639



640

## Descrizione / Description

## Misure / Quotes

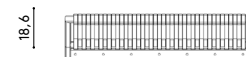
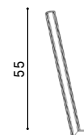
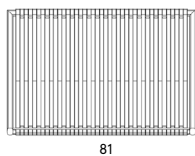

## Caratteristiche / Characteristics

Schienale in alluminio verniciato con intreccio / Backrest in painted aluminium with woven pattern

## Design / Design

Alberto Lievore | 2022

## Dimensioni / Dimensions

81 x 19 x 55 h

## Esterno / Outdoor

Si / Yes

## Struttura / Structure

Alluminio estruso / Extruded aluminium

## Corda / Rope

Corda 100% polipropilene tinto in massa / 100% dyed in the mass polypropylene rope

## Elementi plastici / Plastic elements

Polipropilene e polietilene / Polypropylene and polyethylene

## Finitura / Paint finishes

Verniciatura polveri poliesteri o poliuretaniche/ Paint finish with polyester or polyurethane powders

## Impilabilità / Stackability

Si / Yes

## Viterie assemblaggio / Assembly screws

Acciaio inox / Stainless steel

## Peso netto singolo pezzo / Net weight

2,2 kg

## Pezzi per scatola / Units per package

1 assemblati / 1 assembled

## Dimensione e volume imballo / Packaging dimension and volume

84 x 84 x 14,5 cm 0,102 m<sup>3</sup>

## Peso lordo imballo / Gross weight package

4,5 kg

## Garanzia / Quality guarantee

2 anni / 2 years

## Accessori / Accessories



C7300CS



C7300CSC



C7301CSD



C7301CSS



# Solaris

# C7300B

RV.1-10-2022

## Descrizione / Description

## Misure / Quotes

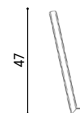
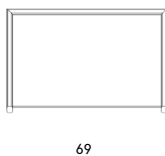
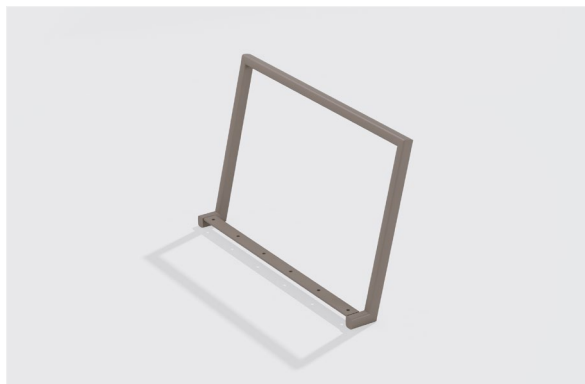

## Caratteristiche / Characteristics

Bracciolo in alluminio verniciato / Armrest in painted aluminium

## Design / Design

Alberto Lievore | 2022

## Dimensioni / Dimensions

69 x 17 x 47 h

## Esterno / Outdoor

Si / Yes

## Struttura / Structure

Alluminio estruso / Extruded aluminium

## Elementi plastici / Plastic elements

/

## Finitura / Paint finishes

Verniciatura polveri poliestere o poliuretaniche / Paint finish with polyester or polyurethane powders

## Impilabilità / Stackability

Si / Yes

## Viterie assemblaggio / Assembly screws

Acciaio inox / Stainless steel

## Peso netto singolo pezzo / Net weight

1 kg

## Pezzi per scatola / Units per package

1 assemblati / 1 assembled

## Dimensione e volume imballo / Packaging dimension and volume

84 x 84 x 14,5 cm 0,102 m<sup>3</sup>

## Peso lordo imballo / Gross weight package

3,2 kg

## Garanzia / Quality guarantee

2 anni / 2 years

## Accessori / Accessories



C7300CB

## Descrizione / Description

## Misure / Quotes

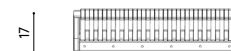
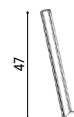
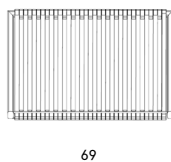
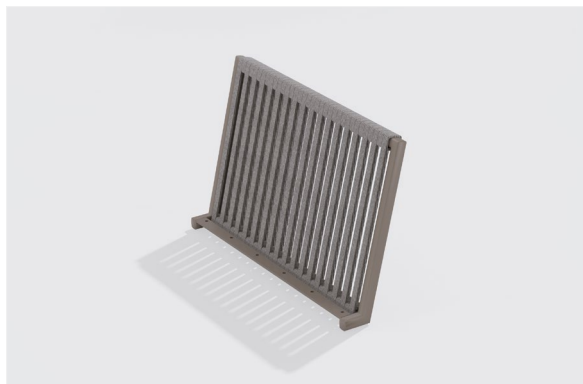

## Caratteristiche / Characteristics

Bracciolo in alluminio verniciato con intreccio / Armrest in painted aluminium with woven pattern

## Design / Design

Alberto Lievore | 2022

## Dimensioni / Dimensions

69 x 17 x 47 h

## Esterno / Outdoor

Si / Yes

## Struttura / Structure

Alluminio estruso / Extruded aluminium

## Corda / Rope

Corda 100% polipropilene tinto in massa / 100% dyed in the mass polypropylene rope

## Elementi plastici / Plastic elements

Polipropilene e polietilene / Polypropylene and polyethylene

## Finitura / Paint finishes

Verniciatura polveri poliesteri o poliuretaniche / Paint finish with polyester or polyurethane powders

## Impilabilità / Stackability

Si / Yes

## Viterie assemblaggio / Assembly screws

Acciaio inox / Stainless steel

## Peso netto singolo pezzo / Net weight

1,8 kg

## Pezzi per scatola / Units per package

1 assemblati / 1 assembled

## Dimensione e volume imballo / Packaging dimension and volume

84 x 84 x 14,5 cm 0,102 m<sup>3</sup>

## Peso lordo imballo / Gross weight package

4 kg

## Garanzia / Quality guarantee

2 anni / 2 years

## Accessori / Accessories



C7300CB

## Descrizione / Description

## Misure / Quotes

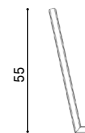
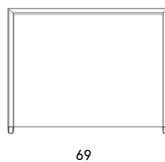
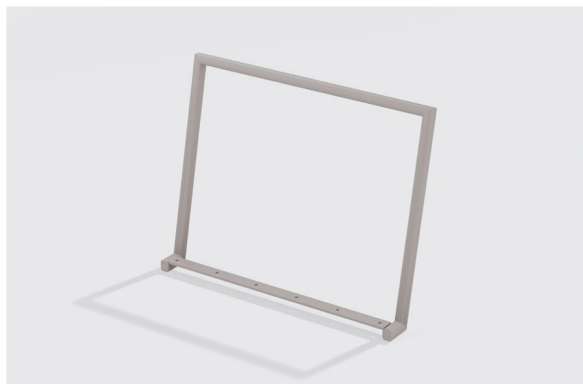

## Caratteristiche / Characteristics

Schienale laterale in alluminio verniciato per modulo esagonale / Side backrest in painted aluminium for hexagonal module

## Design / Design

Alberto Lievore | 2022

## Dimensioni / Dimensions

69 x 17 x 55 h

## Esterno / Outdoor

Si / Yes

## Struttura / Structure

Alluminio estruso / Extruded aluminium

## Elementi plastici / Plastic elements

/

## Finitura / Paint finishes

Verniciatura polveri poliestere o poliuretatiche / Paint finish with polyester or polyurethane powders

## Impilabilità / Stackability

Si / Yes

## Viterie assemblaggio / Assembly screws

Acciaio inox / Stainless steel

## Peso netto singolo pezzo / Net weight

1 kg

## Pezzi per scatola / Units per package

1 assemblati / 1 assembled

## Dimensione e volume imballo / Packaging dimension and volume

84 x 84 x 14,5 cm 0,102 m<sup>3</sup>

## Peso lordo imballo / Gross weight package

3,5 kg

## Garanzia / Quality guarantee

2 anni / 2 years

## Accessori / Accessories



C7300CSD



C7300CSS

## Descrizione / Description

## Misure / Quotes

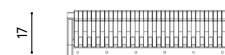
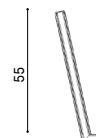
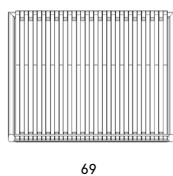

## Caratteristiche / Characteristics

Schienale laterale in alluminio verniciato con intreccio per modulo esagonale / Side backrest in painted aluminium with woven pattern for hexagonal module

## Design / Design

Alberto Lievore | 2022

## Dimensioni / Dimensions

69 x 17 x 55 h

## Esterno / Outdoor

Si / Yes

## Struttura / Structure

Alluminio estruso / Extruded aluminium

## Corda / Rope

Corda 100% polipropilene tinto in massa / 100% dyed in the mass polypropylene rope

## Elementi plastici / Plastic elements

Polipropilene e polietilene / Polypropylene and polyethylene

## Finitura / Paint finishes

Verniciatura polveri poliesteri o poliuretaniche/ Paint finish with polyester or polyurethane powders

## Impilabilità / Stackability

Si / Yes

## Viterie assemblaggio / Assembly screws

Acciaio inox / Stainless steel

## Peso netto singolo pezzo / Net weight

2 kg

## Pezzi per scatola / Units per package

1 assemblati / 1 assembled

## Dimensione e volume imballo / Packaging dimension and volume

84 x 84 x 14,5 cm 0,102 m<sup>3</sup>

## Peso lordo imballo / Gross weight package

4,5 kg

## Garanzia / Quality guarantee

2 anni / 2 years

## Accessori / Accessories



C7300CSD



C7300CSS

## Descrizione / Description

## Misure / Quotes

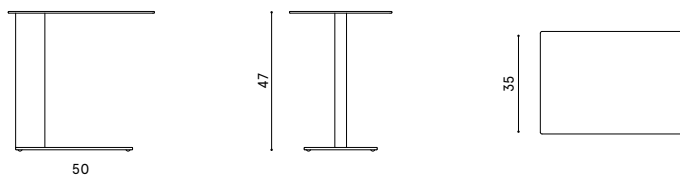

## Caratteristiche / Characteristics

Tavolino in alluminio verniciato / Small table in painted aluminium

## Design / Design

Alberto Lievore | 2022

## Dimensioni / Dimensions

50 x 35 x 47 h

## Esterno / Outdoor

Sì / Yes

## Struttura / Structure

Acciaio, alluminio laminato e estruso / Steel, laminated and extruded aluminium

## Elementi plastici / Plastic elements

Polipropilene e polietilene / Polypropylene and polyethylene

## Finitura / Paint finishes

Verniciatura polveri poliestere o poliuretaniche / Paint finish with polyester or polyurethane powders

## Impilabilità / Stackability

No

## Viterie assemblaggio / Assembly screws

Acciaio inox / Stainless steel

## Peso netto singolo pezzo / Net weight

9,8 kg

## Pezzi per scatola / Units per package

1 assemblati / 1 assembled

## Dimensione e volume imballo / Packaging dimension and volume

60 x 49 x 64 cm 0,188 m<sup>3</sup>

## Peso lordo imballo / Gross weight package

13,3 kg

## Garanzia / Quality guarantee

2 anni / 2 years

## Descrizione / Description

## Misure / Quotes

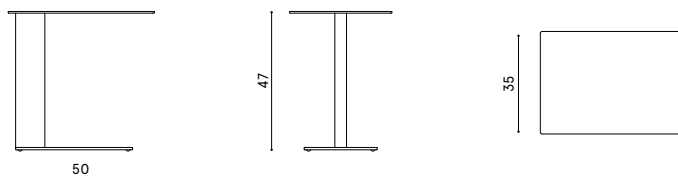

## Caratteristiche / Characteristics

Tavolino in alluminio verniciato con piano in alluminio puntinato / Small table in painted aluminium with top in speckled aluminium

## Design / Design

Alberto Lievore | 2022

## Dimensioni / Dimensions

50 x 35 x 47 h

## Esterno / Outdoor

Sì / Yes

## Struttura / Structure

Acciaio, alluminio laminato e estruso / Steel, laminated and extruded aluminium

## Elementi plastici / Plastic elements

Polipropilene e polietilene / Polypropylene and polyethylene

## Finitura / Paint finishes

Verniciatura polveri poliestere o poliuretaniche ed effetto puntinato / Paint finish with polyester or polyurethane powders and speckled aluminium effect

## Impilabilità / Stackability

No

## Viterie assemblaggio / Assembly screws

Acciaio inox / Stainless steel

## Peso netto singolo pezzo / Net weight

9,8 kg

## Pezzi per scatola / Units per package

1 assemblati / 1 assembled

## Dimensione e volume imballo / Packaging dimension and volume

60 x 49 x 64 cm 0,188 m<sup>3</sup>

## Peso lordo imballo / Gross weight package

13,3 kg

## Garanzia / Quality guarantee

2 anni / 2 years



## Descrizione / Description

## Misure / Quotes

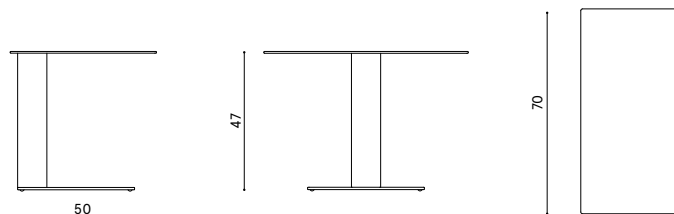

## Caratteristiche / Characteristics

Tavolino in alluminio verniciato / Small table in painted aluminium

## Design / Design

Alberto Lievore | 2022

## Dimensioni / Dimensions

70 x 35 x 47 h

## Esterno / Outdoor

Sì / Yes

## Struttura / Structure

Acciaio, alluminio laminato e estruso / Steel, laminated and extruded aluminium

## Elementi plastici / Plastic elements

Polipropilene e polietilene / Polypropylene and polyethylene

## Finitura / Paint finishes

Verniciatura polveri poliestere o poliuretaniche / Paint finish with polyester or polyurethane powders

## Impilabilità / Stackability

No

## Viterie assemblaggio / Assembly screws

Acciaio inox / Stainless steel

## Peso netto singolo pezzo / Net weight

11 kg

## Pezzi per scatola / Units per package

1 assemblati / 1 assembled

## Dimensione e volume imballo / Packaging dimension and volume

60 x 49 x 64 cm 0,246 m<sup>3</sup>

## Peso lordo imballo / Gross weight package

14,5 kg

## Garanzia / Quality guarantee

2 anni / 2 years

## Descrizione / Description

## Misure / Quotes

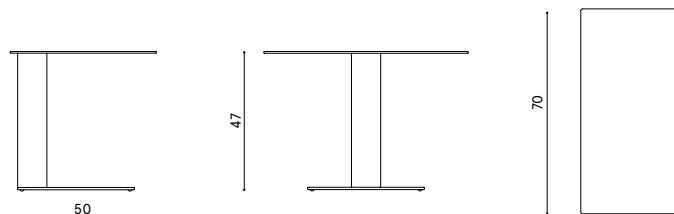

## Caratteristiche / Characteristics

Tavolino in alluminio verniciato con piano in alluminio puntinato / Small table in painted aluminium with top in speckled aluminium

## Design / Design

Alberto Lievore | 2022

## Dimensioni / Dimensions

70 x 35 x 47 h

## Esterno / Outdoor

Si / Yes

## Struttura / Structure

Acciaio, alluminio laminato e estruso / Steel, laminated and extruded aluminium

## Elementi plastici / Plastic elements

Polipropilene e polietilene / Polypropylene and polyethylene

## Finitura / Paint finishes

Verniciatura polveri poliestere o poliuretaniche ed effetto puntinato / Paint finish with polyester or polyurethane powders and speckled aluminium effect

## Impilabilità / Stackability

No

## Viterie assemblaggio / Assembly screws

Acciaio inox / Stainless steel

## Peso netto singolo pezzo / Net weight

11 kg

## Pezzi per scatola / Units per package

1 assemblati / 1 assembled

## Dimensione e volume imballo / Packaging dimension and volume

60 x 49 x 64 cm 0,246 m<sup>3</sup>

## Peso lordo imballo / Gross weight package

14,5 kg

## Garanzia / Quality guarantee

2 anni / 2 years

## Descrizione / Description

## Misure / Quotes

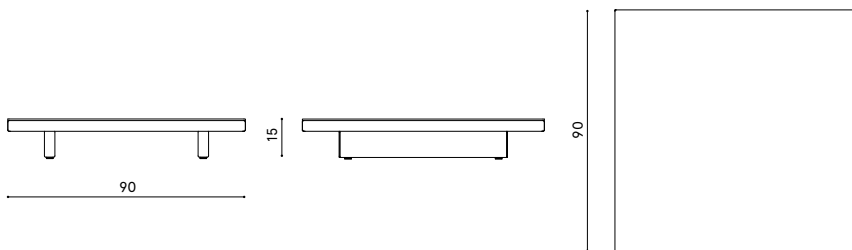

## Caratteristiche / Characteristics

Tavolo basso quadrato in alluminio verniciato / Low square table in painted aluminium

## Design / Design

Alberto Lievore | 2022

## Dimensioni / Dimensions

90 x 90 x 15 h

## Esterno / Outdoor

Si / Yes

## Struttura / Structure

Alluminio laminato e estruso / Laminated and extruded aluminium

## Elementi plastici / Plastic elements

Polipropilene e polietilene / Polypropylene and polyethylene

## Finitura / Paint finishes

Verniciatura polveri poliestere o poliuretaniche / Paint finish with polyester or polyurethane powders

## Impilabilità / Stackability

No

## Viterie assemblaggio / Assembly screws

Acciaio inox / Stainless steel

## Peso netto singolo pezzo / Net weight

12,9 kg

## Pezzi per scatola / Units per package

1 assemblati / 1 assembled

## Dimensione e volume imballo / Packaging dimension and volume

105 x 105 x 22 cm 0,242 m<sup>3</sup>

## Peso lordo imballo / Gross weight package

16,6 kg

## Garanzia / Quality guarantee

2 anni / 2 years

## Descrizione / Description

## Misure / Quotes

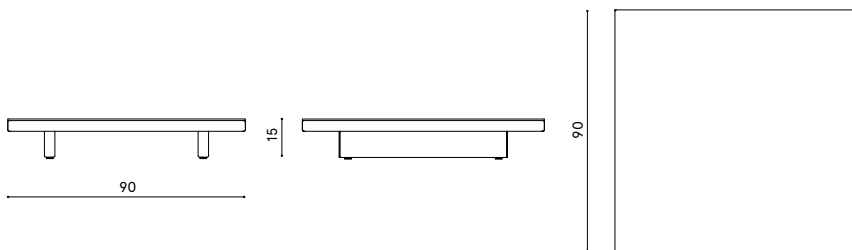

## Caratteristiche / Characteristics

Tavolo basso quadrato in alluminio verniciato con piano in alluminio puntinato / Low square table in painted aluminium with top in speckled aluminium

## Design / Design

Alberto Lievore | 2022

## Dimensioni / Dimensions

90 x 90 x 15 h

## Esterno / Outdoor

Si / Yes

## Struttura / Structure

Alluminio laminato e estruso / Laminated and extruded aluminium

## Elementi plastici / Plastic elements

Polipropilene e polietilene / Polypropylene and polyethylene

## Finitura / Paint finishes

Verniciatura polveri poliestere o poliuretaniche ed effetto puntinato / Paint finish with polyester or polyurethane powders and speckled aluminium effect

## Impilabilità / Stackability

No

## Viterie assemblaggio / Assembly screws

Acciaio inox / Stainless steel

## Peso netto singolo pezzo / Net weight

12,9 kg

## Pezzi per scatola / Units per package

1 assemblati / 1 assembled

## Dimensione e volume imballo / Packaging dimension and volume

105 x 105 x 22 cm 0,242 m<sup>3</sup>

## Peso lordo imballo / Gross weight package

16,6 kg

## Garanzia / Quality guarantee

2 anni / 2 years

# Solaris

# 73T3G

RV.1-10-2022

## Descrizione / Description

## Misure / Quotes

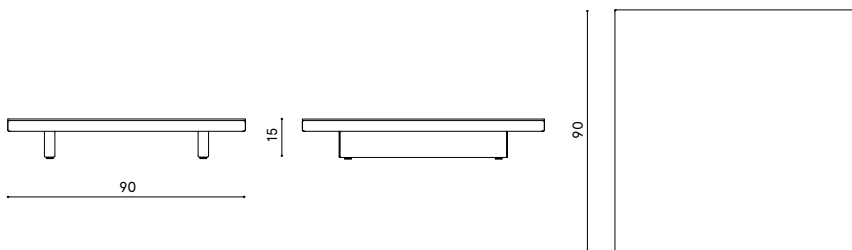

## Caratteristiche / Characteristics

Tavolo basso quadrato in alluminio verniciato con piano in gres porcellanato / Low square table in painted aluminium with top in porcelain stoneware

### Design / Design

Alberto Lievore | 2022

### Dimensioni / Dimensions

90 x 90 x 15 h

### Esterno / Outdoor

Si / Yes

### Struttura / Structure

Alluminio laminato, estruso e gres / Laminated and extruded aluminium and porcelain stoneware

### Elementi plastici / Plastic elements

Polipropilene e polietilene / Polypropylene and polyethylene

### Finitura / Paint finishes

Verniciatura polveri poliesteri o poliuretaniche/ Paint finish with polyester or polyurethane powders

### Impilabilità / Stackability

No

### Viterie assemblaggio / Assembly screws

Acciaio inox / Stainless steel

### Peso netto singolo pezzo / Net weight

19 kg

### Pezzi per scatola / Units per package

1 assemblati / 1 assembled

### Dimensione e volume imballo / Packaging dimension and volume

105 x 105 x 22 cm 0,242 m<sup>3</sup>

### Peso lordo imballo / Gross weight package

22,7 kg

### Garanzia / Quality guarantee

2 anni / 2 years

## Descrizione / Description

## Misure / Quotes

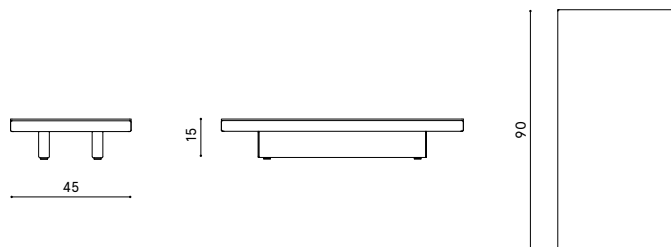

## Caratteristiche / Characteristics

Tavolo basso rettangolare in alluminio verniciato / Low rectangular table in painted aluminium

## Design / Design

Alberto Lievore | 2022

## Dimensioni / Dimensions

90 x 45 x 15 h

## Esterno / Outdoor

Si / Yes

## Struttura / Structure

Alluminio laminato, estruso / Laminated and extruded aluminium

## Elementi plastici / Plastic elements

Polipropilene e polietilene / Polypropylene and polyethylene

## Finitura / Paint finishes

Verniciatura polveri poliestere o poliuretaniche / Paint finish with polyester or polyurethane powders

## Impilabilità / Stackability

No

## Viterie assemblaggio / Assembly screws

Acciaio inox / Stainless steel

## Peso netto singolo pezzo / Net weight

8,6 kg

## Pezzi per scatola / Units per package

1 assemblati / 1 assembled

## Dimensione e volume imballo / Packaging dimension and volume

105 x 60 x 22 cm 0,138 m<sup>3</sup>

## Peso lordo imballo / Gross weight package

12,1 kg

## Garanzia / Quality guarantee

2 anni / 2 years

## Descrizione / Description

## Misure / Quotes

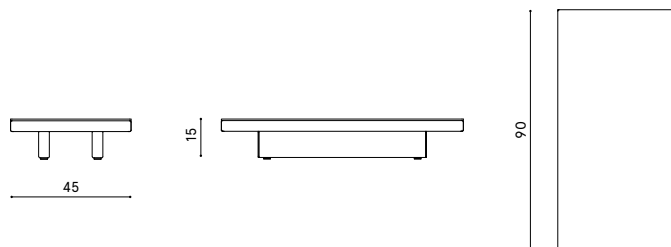

## Caratteristiche / Characteristics

Tavolo basso rettangolare in alluminio verniciato con piano in alluminio puntinato  
Low rectangular table in painted aluminium with top in speckled aluminium

## Design / Design

Alberto Lievore | 2022

## Dimensioni / Dimensions

90 x 45 x 15 h

## Esterno / Outdoor

Si / Yes

## Struttura / Structure

Alluminio laminato, estruso / Laminated and extruded aluminium

## Elementi plastici / Plastic elements

Polipropilene e polietilene / Polypropylene and polyethylene

## Finitura / Paint finishes

Verniciatura polveri poliestere o poliuretatiche ed effetto puntinato / Paint finish with polyester or polyurethane powders and speckled aluminium effect

## Impilabilità / Stackability

No

## Viterie assemblaggio / Assembly screws

Acciaio inox / Stainless steel

## Peso netto singolo pezzo / Net weight

12,9 kg

## Pezzi per scatola / Units per package

1 assemblati / 1 assembled

## Dimensione e volume imballo / Packaging dimension and volume

105 x 60 x 22 cm 0,138 m<sup>3</sup>

## Peso lordo imballo / Gross weight package

16,6 kg

## Garanzia / Quality guarantee

2 anni / 2 years

## Descrizione / Description

## Misure / Quotes

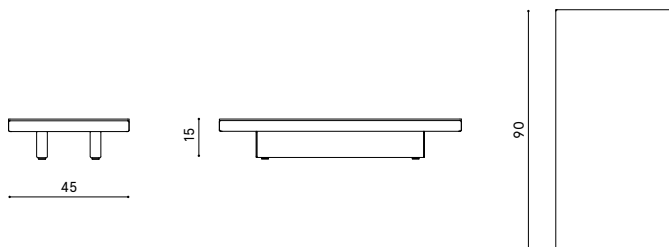

## Caratteristiche / Characteristics

Tavolo basso rettangolare in alluminio verniciato con piano in gres porcellanato  
Low rectangular table in painted aluminium with top in porcelain stoneware

## Design / Design

Alberto Lievore | 2022

## Dimensioni / Dimensions

90 x 45 x 15 h

## Esterno / Outdoor

Si / Yes

## Struttura / Structure

Alluminio laminato, estruso e gres / Laminated and extruded aluminium and porcelain stoneware

## Elementi plastici / Plastic elements

Polipropilene e polietilene / Polypropylene and polyethylene

## Finitura / Paint finishes

Verniciatura polveri poliesteri o poliuretaniche/ Paint finish with polyester or polyurethane powders

## Impilabilità / Stackability

No

## Viterie assemblaggio / Assembly screws

Acciaio inox / Stainless steel

## Peso netto singolo pezzo / Net weight

11,6 kg

## Pezzi per scatola / Units per package

1 assemblati / 1 assembled

## Dimensione e volume imballo / Packaging dimension and volume

105 x 60 x 22 cm 0,138 m<sup>3</sup>

## Peso lordo imballo / Gross weight package

15,1 kg

## Garanzia / Quality guarantee

2 anni / 2 years



## Descrizione / Description

## Misure / Quotes



## Caratteristiche / Characteristics

Set staffe / Set of connectors

## Design / Design

Alberto Lievore | 2022

## Dimensioni / Dimensions

/

## Esterno / Outdoor

Sì / Yes

## Struttura / Structure

Alluminio laminato / Laminated aluminum

## Elementi plastici / Plastic elements

/

## Finitura / Paint finishes

Verniciatura polveri poliestere o poliuretaniche / Paint finish with polyester or polyurethane powders

## Impilabilità / Stackability

No

## Viterie assemblaggio / Assembly screws

Acciaio inox / Stainless steel

## Peso netto singolo pezzo / Net weight

0,16 kg

## Pezzi per scatola / Units per package

2 assemblati / 2 assembled

## Dimensione e volume imballo / Packaging dimension and volume

/

## Peso lordo imballo / Gross weight package

0,3 kg

## Garanzia / Quality guarantee

2 anni / 2 years

## Descrizione / Description

## Misure / Quotes



## Caratteristiche / Characteristics

Set staffe per ancoraggio moduli con tavoli bassi / Connectors to link the modules with the low tables

## Design / Design

Alberto Lievore | 2022

## Dimensioni / Dimensions

/

## Esterno / Outdoor

Si / Yes

## Struttura / Structure

Alluminio laminato / Laminated aluminum

## Elementi plastici / Plastic elements

/

## Finitura / Paint finishes

Verniciatura polveri poliestere o poliuretaniche/ Paint finish with polyester or polyurethane powders

## Impilabilità / Stackability

No

## Viterie assemblaggio / Assembly screws

Acciaio inox / Stainless steel

## Peso netto singolo pezzo / Net weight

0,14 kg

## Pezzi per scatola / Units per package

2 assemblati / 2 assembled

## Dimensione e volume imballo / Packaging dimension and volume

/

## Peso lordo imballo / Gross weight package

0,3 kg

## Garanzia / Quality guarantee

2 anni / 2 years

## По вопросам продаж и поддержки обращайтесь:

Алматы (7273)495-231  
Ангарск (3955)60-70-56  
Архангельск (8182)63-90-72  
Астрахань (8512)99-46-04  
Барнаул (3852)73-04-60  
Белгород (4722)40-23-64  
Благовещенск (4162)22-76-07  
Брянск (4832)59-03-52  
Владивосток (423)249-28-31  
Владикавказ (8672)28-90-48  
Владимир (4922)49-43-18  
Волгоград (844)278-03-48  
Вологда (8172)26-4159  
Воронеж (473)204-51-73  
Екатеринбург (343)384-55-89  
Иваново (4932)77-34-06  
Ижевск (3412)26-03-58  
Иркутск (395)279-98-46  
Казань (843)206-01-48

Калининград (4012)72-03-81  
Калуга (4842)92-23-67  
Кемерово (3842)65-04-62  
Киров (8332)68-02-04  
Коломна (4966)23-41-49  
Кострома (4942)77-07-48  
Краснодар (861)203-40-90  
Красноярск (391)204-63-61  
Курск (4712)77-13-04  
Курган (3522)50-90-47  
Липецк (4742)52-20-81  
Магнитогорск (3519)55-03-13  
Москва (495)268-04-70  
Мурманск (8152)59-64-93  
Набережные Челны (8552)20-53-41  
Нижний Новгород (831)429-08-12  
Новокузнецк (3843)20-46-81  
Ноябрьск (3496)41-32-12  
Новосибирск (383)227-86-73

Омск (3812)21-46-40  
Орел (4862)44-53-42  
Оренбург (3532)37-68-04  
Пенза (8412)22-31-16  
Петрозаводск (8142)55-98-37  
Псков (8112)59-10-37  
Пермь (342)205-81-47  
Ростов-на-Дону (863)308-18-15  
Рязань (4912)46-61-64  
Самара (846)206-03-16  
Саранск (8342)22-96-24  
Санкт-Петербург (812)309-46-40  
Саратов (845)249-38-78  
Севастополь (8692)22-31-93  
Симферополь (3652)67-13-56  
Смоленск (4812)29-41-54  
Сочи (862)225-72-31  
Ставрополь (8652)20-65-13  
Сургут (3462)77-98-35

Сыктывкар (8212)25-95-17  
Тамбов (4752)50-40-97  
Тверь (4822)63-31-35  
Тольятти (8482)63-91-07  
Томск (3822)98-41-53  
Тула (4872)33-79-87  
Тюмень (3452)66-21-18  
Ульяновск (8422)24-23-59  
Улан-Удэ (3012)59-97-51  
Уфа (347)229-48-12  
Хабаровск (4212)92-98-04  
Чебоксары (8352)28-53-07  
Челябинск (351)202-03-61  
Череповец (8202)49-02-64  
Чита (3022)38-34-83  
Якутск (4112)23-90-97  
Ярославль (4852)69-52-93

Россия +7(495)268-04-70

Казахстан +7(7172)727-132

Киргизия +996(312)96-26-47

Адрес: <https://fast.nt-rt.ru/> || эл.почта: [ftj@nt-rt.ru](mailto:ftj@nt-rt.ru)