

# ALLSIZE

## КАТАЛОГ

По вопросам продаж и поддержки обращайтесь:

Алматы (7273)495-231  
Ангарск (3955)60-70-56  
Архангельск (8182)63-90-72  
Астрахань (8512)99-46-04  
Барнаул (3852)73-04-60  
Белгород (4722)40-23-64  
Благовещенск (4162)22-76-07  
Брянск (4832)59-03-52  
Владивосток (423)249-28-31  
Владикавказ (8672)28-90-48  
Владимир (4922)49-43-18  
Волгоград (844)278-03-48  
Вологда (8172)26-4159  
Воронеж (473)204-51-73  
Екатеринбург (343)384-55-89  
Иваново (4932)77-34-06  
Ижевск (3412)26-03-58  
Иркутск (395)279-98-46  
Казань (843)206-01-48

Калининград (4012)72-03-81  
Калуга (4842)92-23-67  
Кемерово (3842)65-04-62  
Киров (8332)68-02-04  
Коломна (4966)23-41-49  
Кострома (4942)77-07-48  
Краснодар (861)203-40-90  
Красноярск (391)204-63-61  
Курск (4712)77-13-04  
Курган (3522)50-90-47  
Липецк (4742)52-20-81  
Магнитогорск (3519)55-03-13  
Москва (495)268-04-70  
Мурманск (8152)59-64-93  
Набережные Челны (8552)20-53-41  
Нижний Новгород (831)429-08-12  
Новокузнецк (3843)20-46-81  
Ноябрьск (3496)41-32-12  
Новосибирск (383)227-86-73

Омск (3812)21-46-40  
Орел (4862)44-53-42  
Оренбург (3532)37-68-04  
Пенза (8412)22-31-16  
Петрозаводск (8142)55-98-37  
Псков (8112)59-10-37  
Пермь (342)205-81-47  
Ростов-на-Дону (863)308-18-15  
Рязань (4912)46-61-64  
Самара (846)206-03-16  
Саранск (8342)22-96-24  
Санкт-Петербург (812)309-46-40  
Саратов (845)249-38-78  
Севастополь (8692)22-31-93  
Симферополь (3652)67-13-56  
Смоленск (4812)29-41-54  
Сочи (862)225-72-31  
Ставрополь (8652)20-65-13  
Сургут (3462)77-98-35

Сыктывкар (8212)25-95-17  
Тамбов (4752)50-40-97  
Тверь (4822)63-31-35  
Тольятти (8482)63-91-07  
Томск (3822)98-41-53  
Тула (4872)33-79-87  
Тюмень (3452)66-21-18  
Ульяновск (8422)24-23-59  
Улан-Удэ (3012)59-97-51  
Уфа (347)229-48-12  
Хабаровск (4212)92-98-04  
Чебоксары (8352)28-53-07  
Челябинск (351)202-03-61  
Череповец (8202)49-02-64  
Чита (3022)38-34-83  
Якутск (4112)23-90-97  
Ярославль (4852)69-52-93

Россия +7(495)268-04-70

Казахстан +7(7172)727-132

Киргизия +996(312)96-26-47

Адрес: <https://fast.nt-rt.ru/> || эл.почта: [ftj@nt-rt.ru](mailto:ftj@nt-rt.ru)

# Allsize

# 57Q09A

RV.4-12-2023

Descrizione / Description

Misure / Quotes

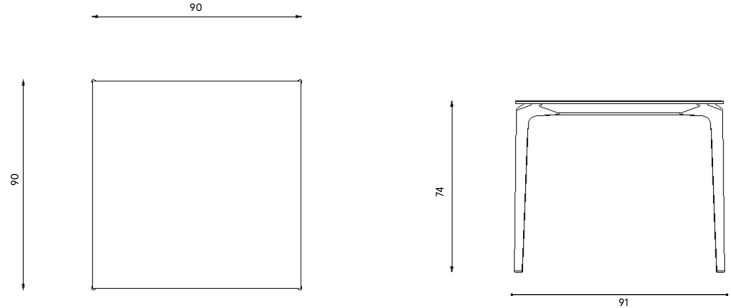
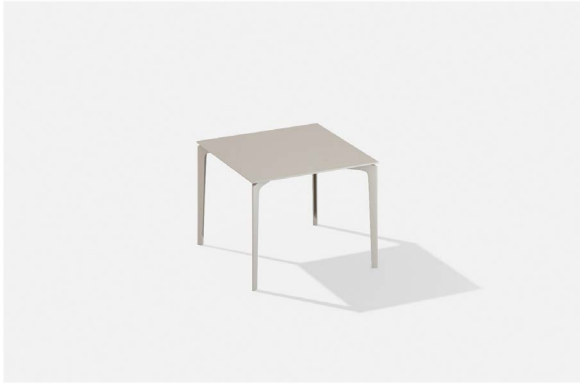

Caratteristiche / Characteristics

Tavolo quadrato in alluminio verniciato / Square table in painted aluminium

Design / Design	Alberto Lievore   2019
Dimensioni / Dimensions	91 x 91 x 74 h
Esterno / Outdoor	Si / Yes
Struttura / Structure	Alluminio pressofuso, estruso e laminato / Die-cast, extruded and laminated aluminium
Elementi plastici / Plastic elements	Polipropilene ed elastomero termoplastico / Polypropylene and thermoplastic elastomer
Finitura / Paint finishes	Verniciatura polveri poliestere o poliuretatiche / Paint finish with polyester or polyurethane powders
Impilabilità / Stackability	No
Viterie assemblaggio / Assembly screws	Acciaio inox / Stainless steel
Peso netto singolo pezzo / Net weight	22.6 kg
Pezzi per scatola / Units per package	1 disassemblato / 1 disassembled
Dimensione e volume imballo / Packaging dimension and volume	144 x 110 x 26 cm 0.412 m <sup>3</sup>
Peso lordo imballo / Gross weight package	29 kg
Garanzia / Quality guarantee	2 anni / 2 years

# Allsize

# 57Q09S

RV.4-12-2023

Descrizione / Description

Misure / Quotes

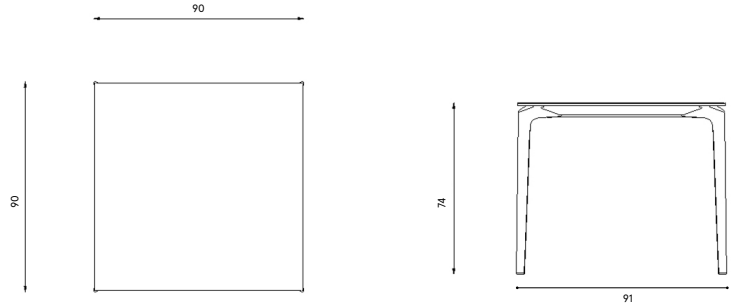

Caratteristiche / Characteristics

Tavolo quadrato in alluminio verniciato con piano in alluminio puntinato / Square table in painted aluminium with top in speckled aluminium

Design / Design

Alberto Lievore | 2019

Dimensioni / Dimensions

91 x 91 x 74 h

Esterno / Outdoor

Si / Yes

Struttura / Structure

Alluminio pressofuso, estruso e laminato / Die-cast, extruded and laminated aluminium

Elementi plastici / Plastic elements

Polipropilene ed elastomero termoplastico / Polypropylene and thermoplastic elastomer

Finitura / Paint finishes

Verniciatura polveri poliestere o poliuretaniche ed effetto puntinato / Paint finish with polyester or polyurethane powders and speckled aluminium effect

Impilabilità / Stackability

No

Viterie assemblaggio / Assembly screws

Acciaio inox / Stainless steel

Peso netto singolo pezzo / Net weight

22.6 kg

Pezzi per scatola / Units per package

1 disassemblato / 1 disassembled

Dimensione e volume imballo / Packaging dimension and volume

144 x 110 x 26 cm 0.412 m<sup>3</sup>

Peso lordo imballo / Gross weight package

29 kg

Garanzia / Quality guarantee

2 anni / 2 years

# Allsize

# 57Q09G

RV.4-12-2023

Descrizione / Description

Misure / Quotes

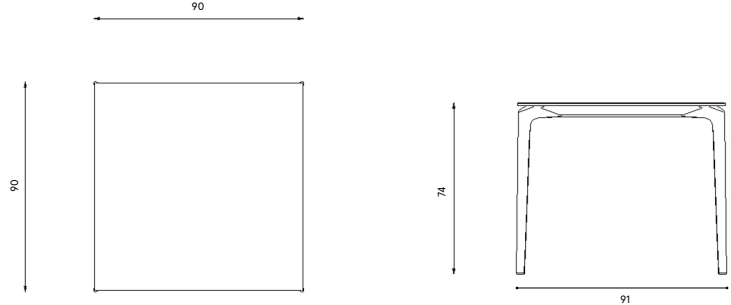

## Caratteristiche / Characteristics

Tavolo quadrato in alluminio verniciato con piano in gres porcellanato / Square table in painted aluminium with porcelain stoneware table top

Design / Design

Alberto Lievore | 2019

Dimensioni / Dimensions

91 x 91 x 74 h

Esterno / Outdoor

Si / Yes

Struttura / Structure

Alluminio pressofuso, estruso con piano in gres porcellanato  
Die-cast, extruded aluminium with porcelain stoneware top

Elementi plastici / Plastic elements

Polipropilene ed elastomero termoplastico / Polypropylene and thermoplastics elastomer

Finitura / Paint finishes

Verniciatura polveri poliesteri o poliuretaniche / Paint finish with polyester or polyurethane powders

Impilabilità / Stackability

No

Viterie assemblaggio / Assembly screws

Acciaio inox / Stainless steel

Peso netto singolo pezzo / Net weight

28 kg

Pezzi per scatola / Units per package

1 disassemblato / 1 disassembled

Dimensione e volume imballo / Packaging dimension and volume

144 x 110 x 26 cm 0.412 m<sup>3</sup>

Peso lordo imballo / Gross weight package

39 kg

Garanzia / Quality guarantee

2 anni / 2 years

# Allsize

# 57Q14A

RV.4-12-2023

Descrizione / Description

Misure / Quotes

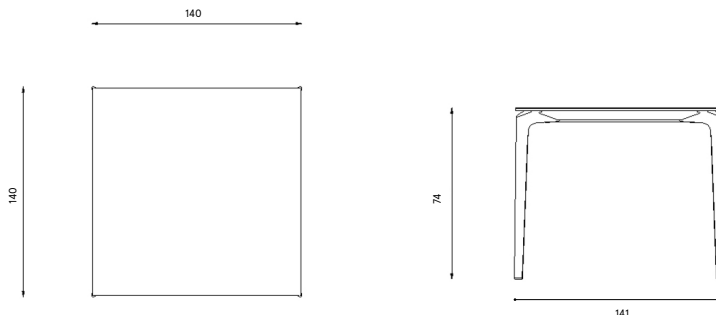

Caratteristiche / Characteristics

Tavolo quadrato in alluminio verniciato / Square table in painted aluminium

Design / Design

Alberto Lievore | 2020

Dimensioni / Dimensions

141 x 141 x 74 h

Esterno / Outdoor

Si / Yes

Struttura / Structure

Alluminio pressofuso, estruso e laminato / Die-cast, extruded and laminated aluminium

Elementi plastici / Plastic elements

Polipropilene ed elastomero termoplastico / Polypropylene and thermoplastics elastomer

Finitura / Paint finishes

Verniciatura polveri poliesteri o poliuretatiche / Paint finish with polyester or polyurethane powders

Impilabilità / Stackability

No

Viterie assemblaggio / Assembly screws

Acciaio inox / Stainless steel

Peso netto singolo pezzo / Net weight

35.5 kg

Pezzi per scatola / Units per package

1 disassemblato / 1 disassembled

Dimensione e volume imballo / Packaging dimension and volume

159 x 159 x 20 cm 0.506 m<sup>3</sup>

Peso lordo imballo / Gross weight package

43 kg

Garanzia / Quality guarantee

2 anni / 2 years

## Descrizione / Description

## Misure / Quotes

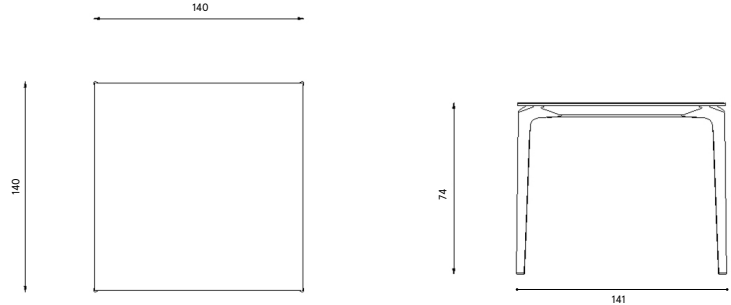

## Caratteristiche / Characteristics

Tavolo quadrato in alluminio verniciato con piano in alluminio puntinato / Square table in painted aluminium with top in speckled aluminium

## Design / Design

Alberto Lievore | 2020

## Dimensioni / Dimensions

141 x 141 x 74 h

## Esterno / Outdoor

Si / Yes

## Struttura / Structure

Alluminio pressofuso, estruso e laminato / Die-cast, extruded and laminated aluminium

## Elementi plastici / Plastic elements

Polipropilene ed elastomero termoplastico / Polypropylene and thermoplastics elastomer

## Finitura / Paint finishes

Verniciatura polveri poliestere o poliuretaniche ed effetto puntinato / Paint finish with polyester or polyurethane powders and speckled aluminium effect

## Impilabilità / Stackability

No

## Viterie assemblaggio / Assembly screws

Acciaio inox / Stainless steel

## Peso netto singolo pezzo / Net weight

35.5 kg

## Pezzi per scatola / Units per package

1 disassemblato / 1 disassembled

## Dimensione e volume imballo / Packaging dimension and volume

159 x 159 x 20 cm 0.506 m<sup>3</sup>

## Peso lordo imballo / Gross weight package

43 kg

## Garanzia / Quality guarantee

2 anni / 2 years

# Allsize

# 57R13A

RV.4-12-2023

Descrizione / Description

Misure / Quotes

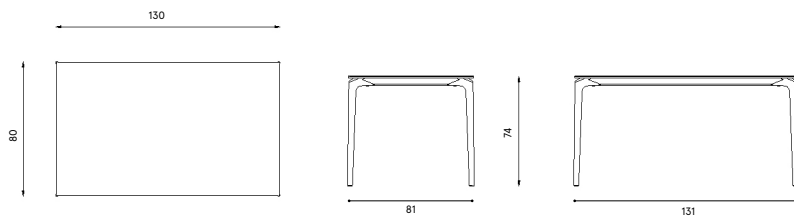

Caratteristiche / Characteristics

Tavolo rettangolare in alluminio verniciato / Rectangular table in painted aluminium

Design / Design

Alberto Lievore | 2019

Dimensioni / Dimensions

131 x 81 x 74 h

Esterno / Outdoor

Si / Yes

Struttura / Structure

Alluminio pressofuso, estruso e laminato / Die-cast, extruded and laminated aluminium

Elementi plastici / Plastic elements

Polipropilene ed elastomero termoplastico / Polypropylene and thermoplastic elastomer

Finitura / Paint finishes

Verniciatura polveri poliestere o poliuretaniche / Paint finish with polyester or polyurethane powders

Impilabilità / Stackability

No

Viterie assemblaggio / Assembly screws

Acciaio inox / Stainless steel

Peso netto singolo pezzo / Net weight

24.5 kg

Pezzi per scatola / Units per package

1 disassemblato / 1 disassembled

Dimensione e volume imballo / Packaging dimension and volume

183 x 110 x 22 cm 0.442 m<sup>3</sup>

Peso lordo imballo / Gross weight package

33 kg

Garanzia / Quality guarantee

2 anni / 2 years

# Allsize

# 57R13S

RV.4-12-2023

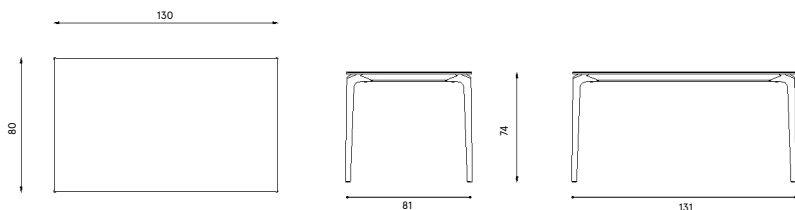
**Descrizione / Description****Misure / Quotes****Caratteristiche / Characteristics**

Tavolo rettangolare in alluminio verniciato con piano in alluminio puntinato /  
Rectangular table in painted aluminium with top in speckled aluminium

Design / Design

Alberto Lievore | 2019

Dimensioni / Dimensions

131 x 81 x 74 h

Esterno / Outdoor

Sì / Yes

Struttura / Structure

Alluminio pressofuso, estruso e laminato / Die-cast, extruded and laminated aluminium

Elementi plastici / Plastic elements

Polipropilene ed elastomero termoplastico / Polypropylene and thermoplastic elastomer

Finitura / Paint finishes

Verniciatura polveri poliestere o poliuretaniche ed effetto puntinato / Paint finish with polyester or polyurethane powders and speckled aluminium effect

Impilabilità / Stackability

No

Viterie assemblaggio / Assembly screws

Acciaio inox / Stainless steel

Peso netto singolo pezzo / Net weight

24.5 kg

Pezzi per scatola / Units per package

1 disassemblato / 1 disassembled

Dimensione e volume imballo / Packaging dimension and volume

183 x 110 x 22 cm 0.442 m<sup>3</sup>

Peso lordo imballo / Gross weight package

33 kg

Garanzia / Quality guarantee

2 anni / 2 years



# Allsize

# 57R13G

RV.4-12-2023

Descrizione / Description

Misure / Quotes

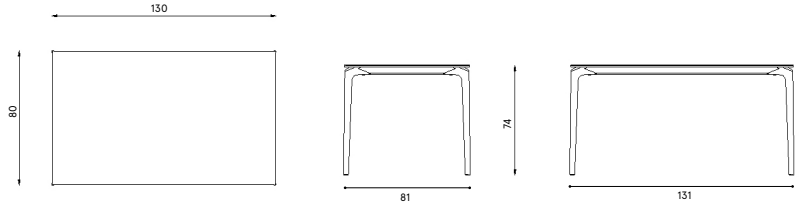

## Caratteristiche / Characteristics

Tavolo rettangolare in alluminio verniciato con piano in gres porcellanato /  
Rectangular table in painted aluminium with top in porcelain stoneware

Design / Design

Alberto Lievore | 2019

Dimensioni / Dimensions

131 x 81 x 74 h

Esterno / Outdoor

Si / Yes

Struttura / Structure

Alluminio pressofuso, estruso e laminato / Die-cast, extruded and laminated aluminium

Elementi plastici / Plastic elements

Polipropilene ed elastomero termoplastico / Polypropylene and thermoplastic elastomer

Finitura / Paint finishes

Verniciatura polveri poliestere o poliuretaniche ed effetto puntinato / Paint finish with polyester or polyurethane powders and speckled aluminium effect

Impilabilità / Stackability

No

Viterie assemblaggio / Assembly screws

Acciaio inox / Stainless steel

Peso netto singolo pezzo / Net weight

24.5 kg

Pezzi per scatola / Units per package

1 disassemblato / 1 disassembled

Dimensione e volume imballo / Packaging dimension and volume

183 x 110 x 22 cm 0.442 m<sup>3</sup>

Peso lordo imballo / Gross weight package

55 kg

Garanzia / Quality guarantee

2 anni / 2 years

# Allsize

# 57R16A

RV.4-12-2023

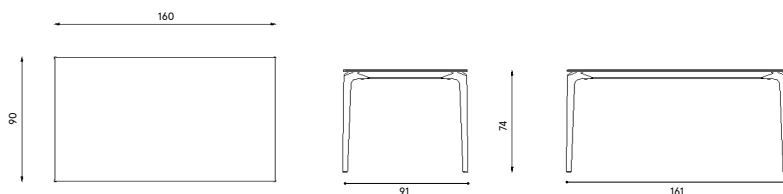
**Descrizione / Description****Misure / Quotes****Caratteristiche / Characteristics**

Tavolo rettangolare in alluminio verniciato / Rectangular table in painted aluminium

Design / Design

Alberto Lievore | 2019

Dimensioni / Dimensions

161 x 91 x 74 h

Esterno / Outdoor

Sì / Yes

Struttura / Structure

Alluminio pressofuso, estruso e laminato / Die-cast, extruded and laminated aluminium

Elementi plastici / Plastic elements

Polipropilene ed elastomero termoplastico / Polypropylene and thermoplastic elastomer

Finitura / Paint finishes

Verniciatura polveri poliesteri o poliuretaniche / Paint finish with polyester or polyurethane powders

Impilabilità / Stackability

No

Viterie assemblaggio / Assembly screws

Acciaio inox / Stainless steel

Peso netto singolo pezzo / Net weight

30 kg

Pezzi per scatola / Units per package

1 disassemblato / 1 disassembled

Dimensione e volume imballo / Packaging dimension and volume

187 x 110 x 22 cm 0.453 m<sup>3</sup>

Peso lordo imballo / Gross weight package

40 kg

Garanzia / Quality guarantee

2 anni / 2 years

# Allsize

# 57R16S

RV.4-12-2023

Descrizione / Description

Misure / Quotes

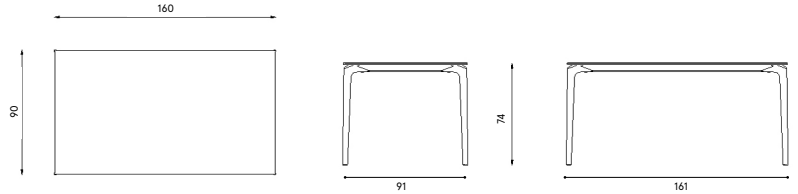

## Caratteristiche / Characteristics

Tavolo rettangolare in alluminio verniciato con piano in alluminio puntinato / Rectangular table in painted aluminium with top in speckled aluminium

Design / Design	Alberto Lievore   2019
Dimensioni / Dimensions	161 x 91 x 74 h
Esterno / Outdoor	Si / Yes
Struttura / Structure	Alluminio pressofuso, estruso e laminato / Die-cast, extruded and laminated aluminium
Elementi plastici / Plastic elements	Polipropilene ed elastomero termoplastico / Polypropylene and thermoplastic elastomer
Finitura / Paint finishes	Verniciatura polveri poliestere o poliuretaniche ed effetto puntinato / Paint finish with polyester or polyurethane powders and speckled aluminium effect
Impilabilità / Stackability	No
Viterie assemblaggio / Assembly screws	Acciaio inox / Stainless steel
Peso netto singolo pezzo / Net weight	30 kg
Pezzi per scatola / Units per package	1 disassemblato / 1 disassembled
Dimensione e volume imballo / Packaging dimension and volume	187 x 110 x 22 cm 0.453 m <sup>3</sup>
Peso lordo imballo / Gross weight package	40 kg
Garanzia / Quality guarantee	2 anni / 2 years

# Allsize

# 57R15G

RV.4-12-2023

Descrizione / Description

Misure / Quotes

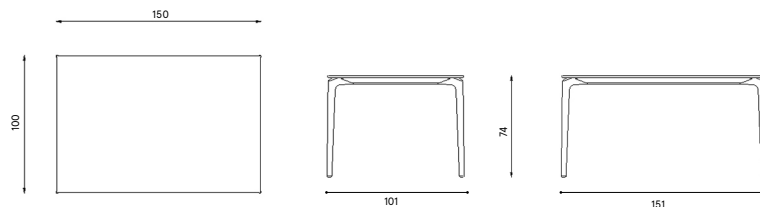

## Caratteristiche / Characteristics

Tavolo rettangolare in alluminio verniciato con piano in gres porcellanato /  
Rectangular table in painted aluminium with porcelain stoneware table top

Design / Design

Alberto Lievore | 2019

Dimensioni / Dimensions

151 x 101 x 74 h

Esterno / Outdoor

Si / Yes

Struttura / Structure

Alluminio pressofuso, estruso con piano in gres porcellanato /  
Die-cast, extruded aluminium with porcelain stoneware top

Elementi plastici / Plastic elements

Polipropilene ed elastomero termoplastico / Polypropylene and thermoplastic elastomer

Finitura / Paint finishes

Verniciatura polveri poliestere o poliuretaniche / Paint finish with polyester or polyurethane powders

Impilabilità / Stackability

No

Viterie assemblaggio / Assembly screws

Acciaio inox / Stainless steel

Peso netto singolo pezzo / Net weight

43 kg

Pezzi per scatola / Units per package

1 disassemblato / 1 disassembled

Dimensione e volume imballo / Packaging dimension and volume

187 x 110 x 25 cm 0.514 m<sup>3</sup>

Peso lordo imballo / Gross weight package

50 kg

Garanzia / Quality guarantee

2 anni / 2 years

# Allsize

# 57R16L

RV.4-12-2023

Descrizione / Description

Misure / Quotes

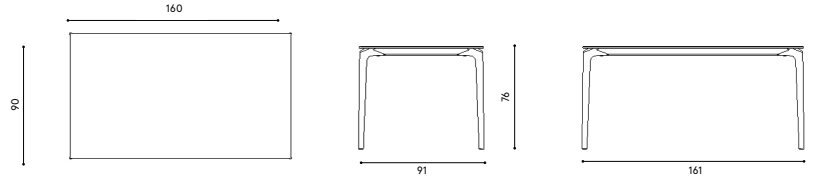

## Caratteristiche / Characteristics

Tavolo rettangolare in alluminio verniciato con piano in Iroko / Rectangular table in painted aluminium with top in Iroko

Design / Design

Alberto Lievore | 2021

Dimensioni / Dimensions

161 x 91 x 76 h

Esterno / Outdoor

Si / Yes

Struttura / Structure

Alluminio pressofuso, estruso e laminato con piano in Iroko / Die-cast, extruded and laminated aluminium with top in Iroko

Elementi plastici / Plastic elements

Polipropilene ed elastomero termoplastico / Polypropylene and thermoplastic elastomer

Finitura / Paint finishes

Verniciatura polveri poliestere o poliuretaniche / Paint finish with polyester or polyurethane powders

Impilabilità / Stackability

No

Viterie assemblaggio / Assembly screws

Acciaio inox / Stainless steel

Peso netto singolo pezzo / Net weight

30 kg

Pezzi per scatola / Units per package

1 disassemblato / 1 disassembled

Dimensione e volume imballo / Packaging dimension and volume

187 x 110 x 25 cm 0.514 m<sup>3</sup>

Peso lordo imballo / Gross weight package

40 kg

Garanzia / Quality guarantee

2 anni / 2 years

# Allsize

# 57R22A

RV.4-12-2023

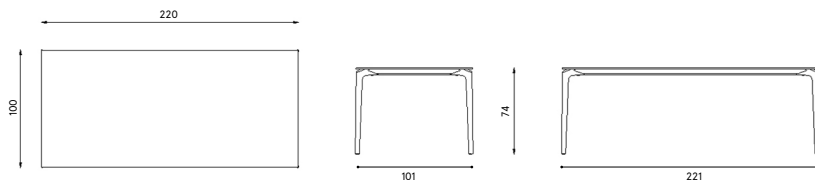
**Descrizione / Description****Misure / Quotes****Caratteristiche / Characteristics**

Tavolo rettangolare in alluminio verniciato / Rectangular table in painted aluminium

Design / Design

Alberto Lievore | 2019

Dimensioni / Dimensions

221 x 101 x 74 h

Esterno / Outdoor

Sì / Yes

Struttura / Structure

Alluminio pressofuso, estruso e laminato / Die-cast, extruded and laminated aluminium

Elementi plastici / Plastic elements

Polipropilene ed elastomero termoplastico / Polypropylene and thermoplastic elastomer

Finitura / Paint finishes

Verniciatura polveri poliesteri o poliuretaniche / Paint finish with polyester or polyurethane powders

Impilabilità / Stackability

No

Viterie assemblaggio / Assembly screws

Acciaio inox / Stainless steel

Peso netto singolo pezzo / Net weight

39 kg

Pezzi per scatola / Units per package

1 disassemblato / 1 disassembled

Dimensione e volume imballo / Packaging dimension and volume

252 x 116 x 20 cm 0.585 m<sup>3</sup>

Peso lordo imballo / Gross weight package

50 kg

Garanzia / Quality guarantee

2 anni / 2 years

# Allsize

# 57R22S

RV.4-12-2023

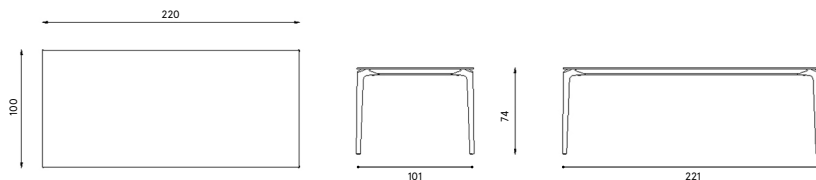
**Descrizione / Description****Misure / Quotes****Caratteristiche / Characteristics**

Tavolo rettangolare in alluminio verniciato con piano in alluminio puntinato  
Rectangular table in painted aluminium with top in speckled aluminium

Design / Design

Alberto Lievore | 2019

Dimensioni / Dimensions

221 x 101 x 74 h

Esterno / Outdoor

Sì / Yes

Struttura / Structure

Alluminio pressofuso, estruso e laminato / Die-cast, extruded and laminated aluminium

Elementi plastici / Plastic elements

Polipropilene ed elastomero termoplastico / Polypropylene and thermoplastic elastomer

Finitura / Paint finishes

Verniciatura polveri poliestere o poliuretaniche ed effetto puntinato / Paint finish with polyester or polyurethane powders and speckled aluminium effect

Impilabilità / Stackability

No

Viterie assemblaggio / Assembly screws

Acciaio inox / Stainless steel

Peso netto singolo pezzo / Net weight

39 kg

Pezzi per scatola / Units per package

1 disassemblato / 1 disassembled

Dimensione e volume imballo / Packaging dimension and volume

252 x 116 x 20 cm 0.585 m<sup>3</sup>

Peso lordo imballo / Gross weight package

50 kg

Garanzia / Quality guarantee

2 anni / 2 years

# Allsize

# 57R22G

RV.4-12-2023

Descrizione / Description

Misure / Quotes

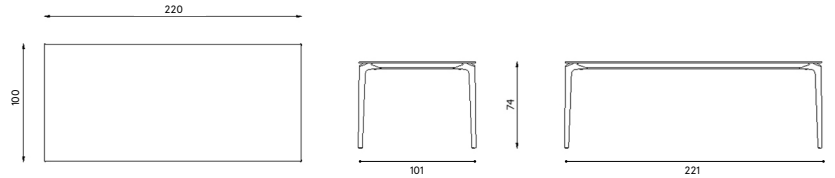

## Caratteristiche / Characteristics

Tavolo rettangolare in alluminio verniciato con piano in gres porcellanato /  
Rectangular table in painted aluminium with porcelain stoneware table top

Design / Design

Alberto Lievore | 2019

Dimensioni / Dimensions

221 x 101 x 74 h

Esterno / Outdoor

Si / Yes

Struttura / Structure

Alluminio pressofuso, estruso con piano in gres porcellanato /  
Die-cast, extruded aluminium with porcelain stoneware top

Elementi plastici / Plastic elements

Polipropilene ed elastomero termoplastico / Polypropylene and thermoplastic elastomer

Finitura / Paint finishes

Verniciatura polveri poliestere o poliuretaniche / Paint finish with polyester or polyurethane powders

Impilabilità / Stackability

No

Viterie assemblaggio / Assembly screws

Acciaio inox / Stainless steel

Peso netto singolo pezzo / Net weight

56 kg

Pezzi per scatola / Units per package

1 disassemblato / 1 disassembled

Dimensione e volume imballo / Packaging dimension and volume

252 x 116 x 20 cm 0.585 m<sup>3</sup>

Peso lordo imballo / Gross weight package

67 kg

Garanzia / Quality guarantee

2 anni / 2 years



# Allsize

# 57R22L

RV.4-12-2023

Descrizione / Description

Misure / Quotes

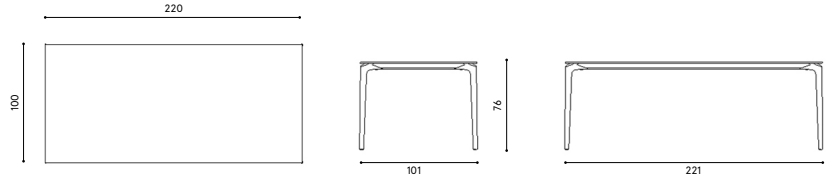

## Caratteristiche / Characteristics

Tavolo rettangolare in alluminio verniciato con piano in Iroko / Rectangular table in painted aluminium with top in Iroko

Design / Design

Alberto Lievore | 2021

Dimensioni / Dimensions

221 x 101 x 76 h

Esterno / Outdoor

Si / Yes

Struttura / Structure

Alluminio pressofuso, estruso e laminato con piano in Iroko / Die-cast, extruded and laminated aluminium with top in Iroko

Elementi plastici / Plastic elements

Polipropilene ed elastomero termoplastico / Polypropylene and thermoplastic elastomer

Finitura / Paint finishes

Verniciatura polveri poliestere o poliuretaniche / Paint finish with polyester or polyurethane powders

Impilabilità / Stackability

No

Viterie assemblaggio / Assembly screws

Acciaio inox / Stainless steel

Peso netto singolo pezzo / Net weight

39 kg

Pezzi per scatola / Units per package

1 disassemblato / 1 disassembled

Dimensione e volume imballo / Packaging dimension and volume

252 x 116 x 25 cm 0.731 m<sup>3</sup>

Peso lordo imballo / Gross weight package

50 kg

Garanzia / Quality guarantee

2 anni / 2 years

# Allsize

# 57R26A

RV.4-12-2023

Descrizione / Description

Misure / Quotes

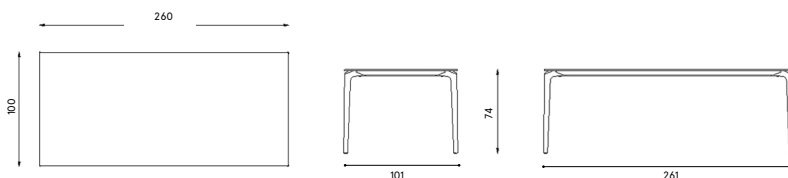

Caratteristiche / Characteristics

Tavolo rettangolare in alluminio verniciato / Rectangular table in painted aluminium

Design / Design

Alberto Lievore | 2019

Dimensioni / Dimensions

261 x 101 x 74 h

Esterno / Outdoor

Si / Yes

Struttura / Structure

Alluminio pressofuso, estruso e laminato / Die-cast, extruded and laminated aluminium

Elementi plastici / Plastic elements

Polipropilene ed elastomero termoplastico / Polypropylene and thermoplastic elastomer

Finitura / Paint finishes

Verniciatura polveri poliesteri o poliuretaniche / Paint finish with polyester or polyurethane powders

Impilabilità / Stackability

No

Viterie assemblaggio / Assembly screws

Acciaio inox / Stainless steel

Peso netto singolo pezzo / Net weight

45.3 kg

Pezzi per scatola / Units per package

1 disassemblato / 1 disassembled

Dimensione e volume imballo / Packaging dimension and volume

285 x 115 x 22 cm 0.721 m<sup>3</sup>

Peso lordo imballo / Gross weight package

57 kg

Garanzia / Quality guarantee

2 anni / 2 years

# Allsize

# 57R26S

RV.4-12-2023

Descrizione / Description

Misure / Quotes

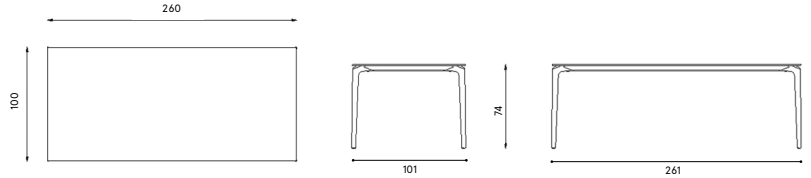

## Caratteristiche / Characteristics

Tavolo rettangolare in alluminio verniciato con piano in alluminio puntinato  
Rectangular table in painted aluminium with top in speckled aluminium

Design / Design

Alberto Lievore | 2019

Dimensioni / Dimensions

261 x 101 x 74 h

Esterno / Outdoor

Si / Yes

Struttura / Structure

Alluminio pressofuso, estruso e laminato / Die-cast, extruded and laminated aluminium

Elementi plastici / Plastic elements

Polipropilene ed elastomero termoplastico / Polypropylene and thermoplastic elastomer

Finitura / Paint finishes

Verniciatura polveri poliestere o poliuretaniche ed effetto puntinato / Paint finish with polyester or polyurethane powders and speckled aluminium effect

Impilabilità / Stackability

No

Viterie assemblaggio / Assembly screws

Acciaio inox / Stainless steel

Peso netto singolo pezzo / Net weight

45.3 kg

Pezzi per scatola / Units per package

1 disassemblato / 1 disassembled

Dimensione e volume imballo / Packaging dimension and volume

285 x 115 x 22 cm 0.721 m<sup>3</sup>

Peso lordo imballo / Gross weight package

57 kg

Garanzia / Quality guarantee

2 anni / 2 years

# Allsize

# 57R26G

RV.4-12-2023

Descrizione / Description

Misure / Quotes

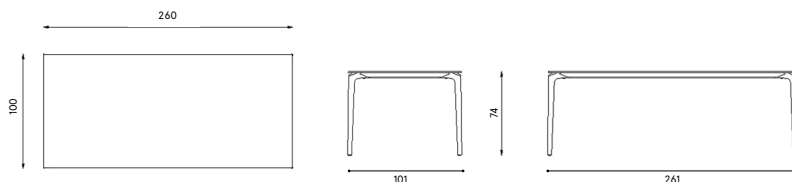
**Caratteristiche / Characteristics**

Tavolo rettangolare in alluminio verniciato con piano in gres porcellanato /  
Rectangular table in painted aluminium with porcelain stoneware table top

Design / Design

Alberto Lievore | 2019

Dimensioni / Dimensions

261 x 101 x 74 h

Esterno / Outdoor

Sì / Yes

Struttura / Structure

Alluminio pressofuso, estruso con piano in gres porcellanato  
Die-cast, extruded aluminium with porcelain stoneware top

Elementi plastici / Plastic elements

Polipropilene ed elastomero termoplastico / Polypropylene and thermoplastic  
elastomer

Finitura / Paint finishes

Verniciatura polveri poliestere o poliuretaniche / Paint finish with polyester or  
polyurethane powders

Impilabilità / Stackability

No

Viterie assemblaggio / Assembly screws

Acciaio inox / Stainless steel

Peso netto singolo pezzo / Net weight

67.3 kg

Pezzi per scatola / Units per package

1 disassemblato / 1 disassembled

Dimensione e volume imballo / Packaging dimension and  
volume285 x 115 x 22 cm 0.721 m<sup>3</sup>

Peso lordo imballo / Gross weight package

80 kg

Garanzia / Quality guarantee

2 anni / 2 years

# Allsize

# 57R30A

RV.4-12-2023

Descrizione / Description

Misure / Quotes

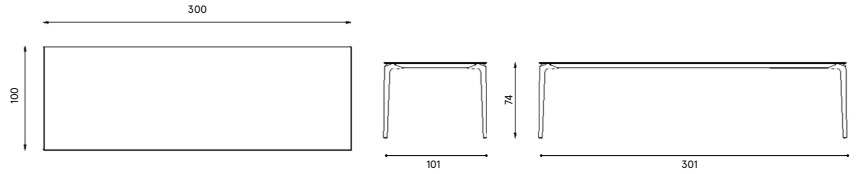

Caratteristiche / Characteristics

Tavolo rettangolare in alluminio verniciato / Rectangular table in painted aluminium

Design / Design

Alberto Lievore | 2019

Dimensioni / Dimensions

301 x 101 x 74 h

Esterno / Outdoor

Si / Yes

Struttura / Structure

Alluminio pressofuso, estruso e laminato / Die-cast, extruded and laminated aluminium

Elementi plastici / Plastic elements

Polipropilene ed elastomero termoplastico / Polypropylene and thermoplastic elastomer

Finitura / Paint finishes

Verniciatura polveri poliesteri o poliuretatiche / Paint finish with polyester or polyurethane powders

Impilabilità / Stackability

No

Viterie assemblaggio / Assembly screws

Acciaio inox / Stainless steel

Peso netto singolo pezzo / Net weight

49 kg

Pezzi per scatola / Units per package

1 disassemblato / 1 disassembled

Dimensione e volume imballo / Packaging dimension and volume

317 x 117 x 22 cm 0.816 m<sup>3</sup>

Peso lordo imballo / Gross weight package

60 kg

Garanzia / Quality guarantee

2 anni / 2 years

# Allsize

# 57R30S

RV.4-12-2023

Descrizione / Description

Misure / Quotes

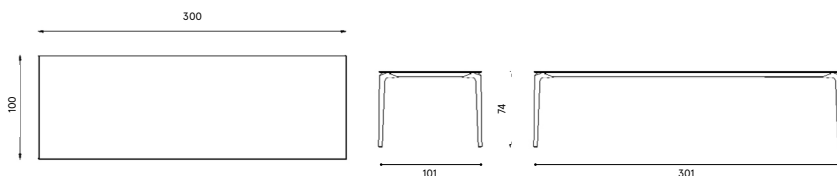

## Caratteristiche / Characteristics

Tavolo rettangolare in alluminio verniciato con piano in alluminio puntinato /  
Rectangular table in painted aluminium with top in speckled aluminium

Design / Design	Alberto Lievore   2019
Dimensioni / Dimensions	301 x 101 x 74 h
Esterno / Outdoor	Si / Yes
Struttura / Structure	Alluminio pressofuso, estruso e laminato / Die-cast, extruded and laminated aluminium
Elementi plastici / Plastic elements	Polipropilene ed elastomero termoplastico / Polypropylene and thermoplastic elastomer
Finitura / Paint finishes	Verniciatura polveri poliestere o poliuretaniche ed effetto puntinato / Paint finish with polyester or polyurethane powders and speckled aluminium effect
Impilabilità / Stackability	No
Viterie assemblaggio / Assembly screws	Acciaio inox / Stainless steel
Peso netto singolo pezzo / Net weight	49 kg
Pezzi per scatola / Units per package	1 disassemblato / 1 disassembled
Dimensione e volume imballo / Packaging dimension and volume	315 x 117 x 22 cm 0.816 m <sup>3</sup>
Peso lordo imballo / Gross weight package	60 kg
Garanzia / Quality guarantee	2 anni / 2 years

# Allsize

# 57R30G

RV.4-12-2023

Descrizione / Description

Misure / Quotes

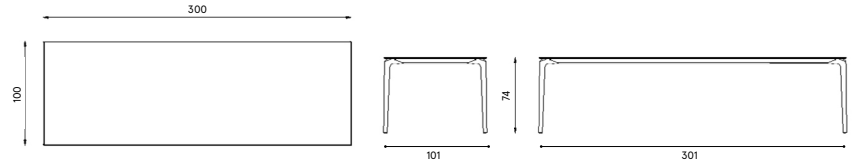

## Caratteristiche / Characteristics

Tavolo rettangolare in alluminio verniciato con piano in gres porcellanato /  
Rectangular table in painted aluminium with porcelain stoneware table top

Design / Design

Alberto Lievore | 2019

Dimensioni / Dimensions

301 x 101 x 74 h

Esterno / Outdoor

Si / Yes

Struttura / Structure

Alluminio pressofuso, estruso con piano in gres porcellanato /  
Die-cast, extruded aluminium with porcelain stoneware top

Elementi plastici / Plastic elements

Polipropilene ed elastomero termoplastico / Polypropylene and thermoplastic elastomer

Finitura / Paint finishes

Verniciatura polveri poliestere o poliuretatiche / Paint finish with polyester or polyurethane powders

Impilabilità / Stackability

No

Viterie assemblaggio / Assembly screws

Acciaio inox / Stainless steel

Peso netto singolo pezzo / Net weight

72 kg

Pezzi per scatola / Units per package

1 disassemblato / 1 disassembled

Dimensione e volume imballo / Packaging dimension and volume

315 x 117 x 22 cm 0.811 m<sup>3</sup>

Peso lordo imballo / Gross weight package

90 kg

Garanzia / Quality guarantee

2 anni / 2 years

# Allsize

# 57R30L

RV.4-12-2023

Descrizione / Description

Misure / Quotes

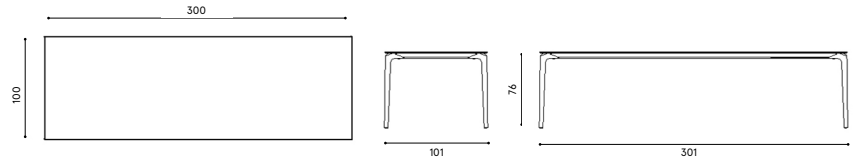

## Caratteristiche / Characteristics

Tavolo rettangolare in alluminio verniciato con piano in Iroko / Rectangular table in painted aluminium with top in Iroko

Design / Design

Alberto Lievore | 2021

Dimensioni / Dimensions

301 x 101 x 76 h

Esterno / Outdoor

Si / Yes

Struttura / Structure

Alluminio pressofuso, estruso e laminato con piano in Iroko / Die-cast, extruded and laminated aluminium with top in Iroko

Elementi plastici / Plastic elements

Polipropilene ed elastomero termoplastico / Polypropylene and thermoplastic elastomer

Finitura / Paint finishes

Verniciatura polveri poliesteri o poliuretaniche / Paint finish with polyester or polyurethane powders

Impilabilità / Stackability

No

Viterie assemblaggio / Assembly screws

Acciaio inox / Stainless steel

Peso netto singolo pezzo / Net weight

49 kg

Pezzi per scatola / Units per package

1 disassemblato / 1 disassembled

Dimensione e volume imballo / Packaging dimension and volume

315 x 117 x 25 cm 0.921 m<sup>3</sup>

Peso lordo imballo / Gross weight package

60 kg

Garanzia / Quality guarantee

2 anni / 2 years



# Allsize

# 57R35A

RV.4-12-2023

Descrizione / Description

Misure / Quotes

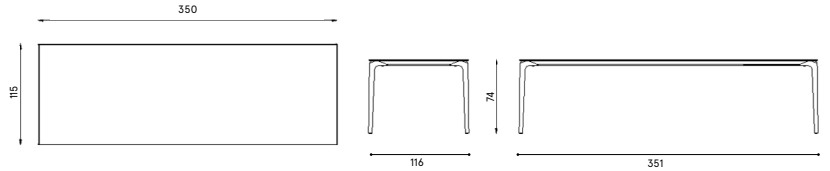

Caratteristiche / Characteristics

Tavolo rettangolare in alluminio verniciato / Rectangular table in painted aluminium

Design / Design

Alberto Lievore | 2021

Dimensioni / Dimensions

351 x 116 x 74 h

Esterno / Outdoor

Si / Yes

Struttura / Structure

Alluminio pressofuso, estruso e laminato / Die-cast, extruded and laminated aluminium

Elementi plastici / Plastic elements

Polipropilene ed elastomero termoplastico / Polypropylene and thermoplastic elastomer

Finitura / Paint finishes

Verniciatura polveri poliestere o poliuretatiche / Paint finish with polyester or polyurethane powders

Impilabilità / Stackability

No

Viterie assemblaggio / Assembly screws

Acciaio inox / Stainless steel

Peso netto singolo pezzo / Net weight

60 kg

Pezzi per scatola / Units per package

1 disassemblato / 1 disassembled

Dimensione e volume imballo / Packaging dimension and volume

365 x 130 x 22 cm 1.044 m<sup>3</sup>

Peso lordo imballo / Gross weight package

75 kg

Garanzia / Quality guarantee

2 anni / 2 years

# Allsize

# 57R35S

RV.4-12-2023

Descrizione / Description

Misure / Quotes

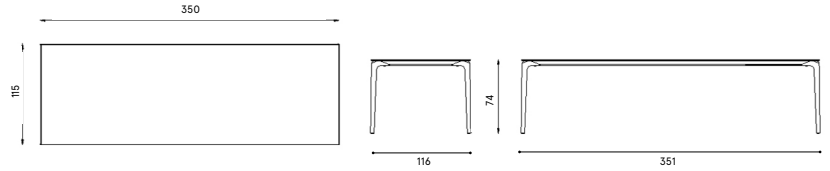

## Caratteristiche / Characteristics

Tavolo rettangolare in alluminio verniciato con piano in alluminio puntinato / Rectangular table in painted aluminium with top in speckled aluminium

Design / Design

Alberto Lievore | 2021

Dimensioni / Dimensions

351 x 116 x 74 h

Esterno / Outdoor

Si / Yes

Struttura / Structure

Alluminio pressofuso, estruso e laminato / Die-cast, extruded and laminated aluminium

Elementi plastici / Plastic elements

Polipropilene ed elastomero termoplastico / Polypropylene and thermoplastic elastomer

Finitura / Paint finishes

Verniciatura polveri poliestere o poliuretaniche ed effetto puntinato / Paint finish with polyester or polyurethane powders and speckled aluminium effect

Impilabilità / Stackability

No

Viterie assemblaggio / Assembly screws

Acciaio inox / Stainless steel

Peso netto singolo pezzo / Net weight

60 kg

Pezzi per scatola / Units per package

1 disassemblato / 1 disassembled

Dimensione e volume imballo / Packaging dimension and volume

365 x 130 x 22 cm 1.044 m<sup>3</sup>

Peso lordo imballo / Gross weight package

75 kg

Garanzia / Quality guarantee

2 anni / 2 years

# Allsize

# 58R16A

RV.4-12-2023

Descrizione / Description

Misure / Quotes

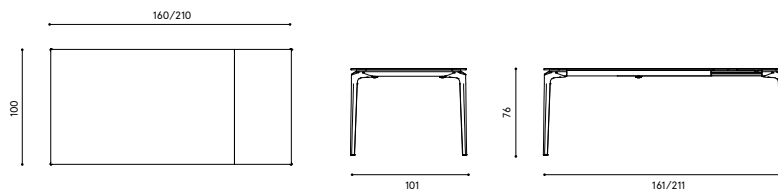

## Caratteristiche / Characteristics

Tavolo rettangolare allungabile in alluminio verniciato con prolunga / Extendible rectangular table in painted aluminium, with extension

Design / Design

Alberto Lievore | 2019

Dimensioni / Dimensions

161/211 x 101 x 76 h

Esterno / Outdoor

Si / Yes

Struttura / Structure

Alluminio pressofuso, estruso e laminato / Die-cast, extruded and laminated aluminium

Elementi plastici / Plastic elements

Polipropilene ed elastomero termoplastico / Polypropylene and thermoplastic elastomer

Finitura / Paint finishes

Verniciatura polveri poliestere o poliuretaniche / Paint finish with polyester or polyurethane powders

Impilabilità / Stackability

No

Viterie assemblaggio / Assembly screws

Acciaio inox / Stainless steel

Peso netto singolo pezzo / Net weight

25.7 / 31.7 kg

Pezzi per scatola / Units per package

1 disassemblato / 1 disassembled

Dimensione e volume imballo / Packaging dimension and volume

216 x 116 x 20 cm 0.501 m<sup>3</sup>

Peso lordo imballo / Gross weight package

60 kg

Garanzia / Quality guarantee

2 anni / 2 years

# Allsize

# 58R16S

RV.4-12-2023

Descrizione / Description

Misure / Quotes

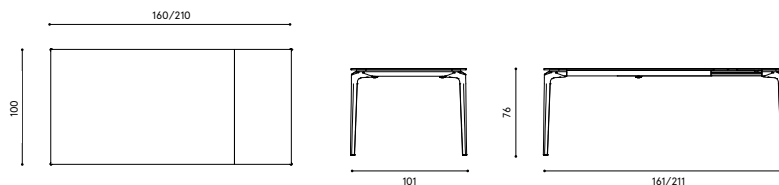

## Caratteristiche / Characteristics

Tavolo rettangolare allungabile in alluminio verniciato con piano in alluminio puntinato e prolunga / Extendible rectangular table in painted aluminium with top in speckled aluminium and extension

Design / Design

Alberto Lievore | 2019

Dimensioni / Dimensions

161/211 x 101 x 76 h

Esterno / Outdoor

Si / Yes

Struttura / Structure

Alluminio pressofuso, estruso e laminato / Die-cast, extruded and laminated aluminium

Elementi plastici / Plastic elements

Polipropilene ed elastomero termoplastico / Polypropylene and thermoplastic elastomer

Finitura / Paint finishes

Verniciatura polveri poliuretatiche ed effetto puntinato / Polyurethane powder coating with and speckled aluminium effect

Impilabilità / Stackability

No

Viterie assemblaggio / Assembly screws

Acciaio inox / Stainless steel

Peso netto singolo pezzo / Net weight

25.7 / 31.7 kg

Pezzi per scatola / Units per package

1 disassemblato / 1 disassembled

Dimensione e volume imballo / Packaging dimension and volume

216 x 116 x 20 cm 0.501 m<sup>3</sup>

Peso lordo imballo / Gross weight package

60 kg

Garanzia / Quality guarantee

2 anni / 2 years

# Allsize

# 58R16G

RV.4-12-2023

Descrizione / Description

Misure / Quotes

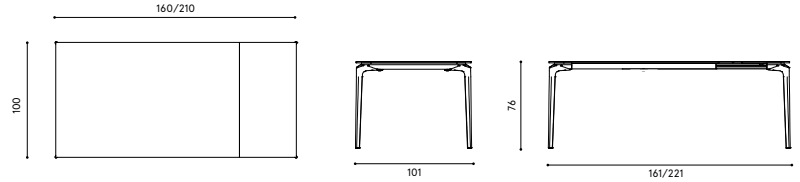

## Caratteristiche / Characteristics

Tavolo rettangolare allungabile in alluminio verniciato con piano e prolunga in gres porcellanato (sp. 6 mm). Predisposto per una seconda prolunga / Extendible rectangular table in painted aluminium with top and extension in porcelain stoneware (th. 6 mm). Ready for a second extension.

Design / Design

Alberto Lievore | 2019

Dimensioni / Dimensions

161/211 x 101 x 76 h

Esterno / Outdoor

Si / Yes

Struttura / Structure

Alluminio pressofuso, estruso con piano in gres porcellanato / Die-cast, extruded aluminium with porcelain stoneware top

Elementi plastici / Plastic elements

Polipropilene ed elastomero termoplastico / Polypropylene and thermoplastic elastomer

Finitura / Paint finishes

Verniciatura polveri poliuretatiche ed effetto puntinato / Polyurethane powder coating with and speckled aluminium effect

Impilabilità / Stackability

No

Viterie assemblaggio / Assembly screws

Acciaio inox / Stainless steel

Peso netto singolo pezzo / Net weight

55 / 70 kg

Pezzi per scatola / Units per package

1 disassemblato / 1 disassembled

Dimensione e volume imballo / Packaging dimension and volume

216 x 116 x 20 cm 0.501 m<sup>3</sup>

Peso lordo imballo / Gross weight package

85 kg

Garanzia / Quality guarantee

2 anni / 2 years

# Allsize

# 58R22A

RV.4-12-2023

Descrizione / Description

Misure / Quotes

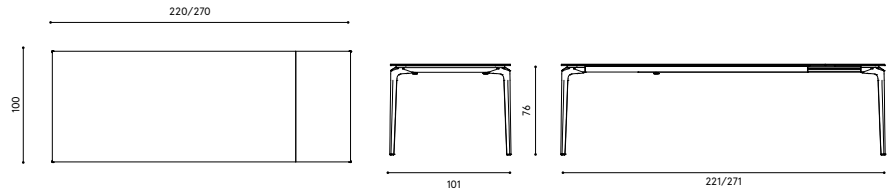

## Caratteristiche / Characteristics

Tavolo rettangolare allungabile in alluminio verniciato con prolunga / Extendible rectangular table in painted aluminium, with extension

Design / Design

Alberto Lievore | 2019

Dimensioni / Dimensions

221/271 x 101 x 76 h

Esterno / Outdoor

Si / Yes

Struttura / Structure

Alluminio pressofuso, estruso e laminato / Die-cast, extruded and laminated aluminium

Elementi plastici / Plastic elements

Polipropilene ed elastomero termoplastico / Polypropylene and thermoplastic elastomer

Finitura / Paint finishes

Verniciatura polveri poliestere o poliuretatiche / Paint finish with polyester or polyurethane powders

Impilabilità / Stackability

No

Viterie assemblaggio / Assembly screws

Acciaio inox / Stainless steel

Peso netto singolo pezzo / Net weight

31.5 / 37.5 kg

Pezzi per scatola / Units per package

1 disassemblato / 1 disassembled

Dimensione e volume imballo / Packaging dimension and volume

252 x 116 x 21 cm 0.614 m<sup>3</sup>

Peso lordo imballo / Gross weight package

76 kg

Garanzia / Quality guarantee

2 anni / 2 years

# Allsize

# 58R22S

RV.4-12-2023

Descrizione / Description

Misure / Quotes

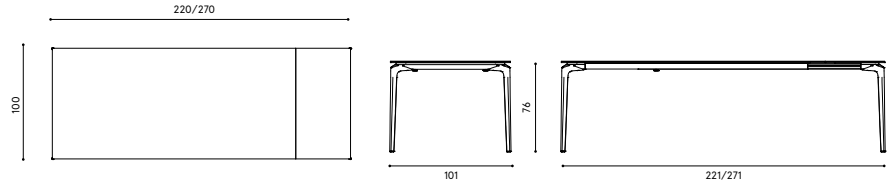

## Caratteristiche / Characteristics

Tavolo rettangolare allungabile in alluminio verniciato con piano in alluminio puntinato e prolunga / Extendible rectangular table in painted aluminium with top in speckled aluminium and extension

Design / Design

Alberto Lievore | 2019

Dimensioni / Dimensions

221/271 x 101 x 76 h

Esterno / Outdoor

Si / Yes

Struttura / Structure

Alluminio pressofuso, estruso e laminato / Die-cast, extruded and laminated aluminium

Elementi plastici / Plastic elements

Polipropilene ed elastomero termoplastico / Polypropylene and thermoplastic elastomer

Finitura / Paint finishes

Verniciatura polveri poliuretatiche ed effetto puntinato / Polyurethane powder coating with and speckled aluminium effect

Impilabilità / Stackability

No

Viterie assemblaggio / Assembly screws

Acciaio inox / Stainless steel

Peso netto singolo pezzo / Net weight

31.5 / 37.5 kg

Pezzi per scatola / Units per package

1 disassemblato / 1 disassembled

Dimensione e volume imballo / Packaging dimension and volume

252 x 116 x 21 cm 0.614 m<sup>3</sup>

Peso lordo imballo / Gross weight package

76 kg

Garanzia / Quality guarantee

2 anni / 2 years

# Allsize

# 58R22G

RV.4-12-2023

Descrizione / Description

Misure / Quotes

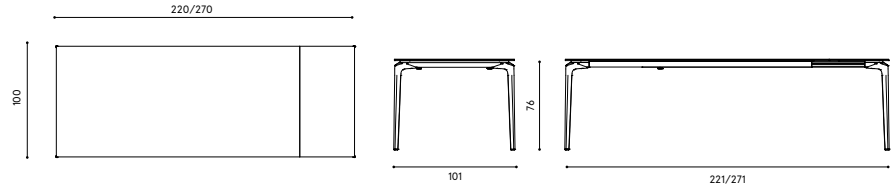

## Caratteristiche / Characteristics

Tavolo rettangolare allungabile in alluminio verniciato con piano e prolunga in gres porcellanato (sp. 6 mm). Predisposto per una seconda prolunga / Extendible rectangular table in painted aluminium with top and extension in porcelain stoneware (th. 6 mm). Ready for a second extension.

Design / Design

Alberto Lievore | 2023

Dimensioni / Dimensions

221/271 x 101 x 76 h

Esterno / Outdoor

Si / Yes

Struttura / Structure

Alluminio pressofuso, estruso con piano in gres porcellanato / Die-cast, extruded aluminium with porcelain stoneware top

Elementi plastici / Plastic elements

Polipropilene ed elastomero termoplastico / Polypropylene and thermoplastic elastomer

Finitura / Paint finishes

Verniciatura polveri poliuretatiche ed effetto puntinato / Polyurethane powder coating with and speckled aluminium effect

Impilabilità / Stackability

No

Viterie assemblaggio / Assembly screws

Acciaio inox / Stainless steel

Peso netto singolo pezzo / Net weight

68 / 80 kg

Pezzi per scatola / Units per package

1 disassemblato / 1 disassembled

Dimensione e volume imballo / Packaging dimension and volume

252 x 116 x 21 cm 0.614 m<sup>3</sup>

Peso lordo imballo / Gross weight package

101 kg

Garanzia / Quality guarantee

2 anni / 2 years



# Allsize

# 58P10

RV.4-12-2023

Descrizione / Description

Misure / Quotes

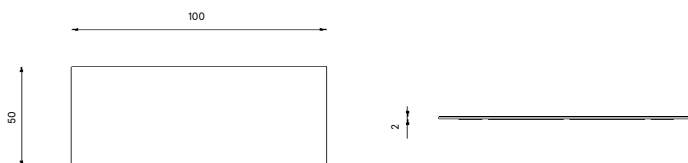
**Caratteristiche / Characteristics**

Prolunga aggiuntiva in alluminio verniciato/puntinato  
Additional extension in painted/speckled aluminium

Design / Design

Alberto Lievore | 2019

Dimensioni / Dimensions

50 x 101

Esterno / Outdoor

Sì / Yes

Struttura / Structure

Alluminio pressofuso, estruso e laminato / Die-cast, extruded and laminated aluminium

Elementi plastici / Plastic elements

Polipropilene ed elastomero termoplastico / Polypropylene and thermoplastic elastomer

Finitura / Paint finishes

Verniciatura polveri poliesteri o poliuretaniche / Paint finish with polyester or polyurethane powders

Impilabilità / Stackability

No

Viterie assemblaggio / Assembly screws

Acciaio inox / Stainless steel

Peso netto singolo pezzo / Net weight

6 kg

Pezzi per scatola / Units per package

1 assemblato / 1 assembled

Dimensione e volume imballo / Packaging dimension and volume

116 x 63 x 11 cm    0.080 m<sup>3</sup>

Peso lordo imballo / Gross weight package

8 kg

Garanzia / Quality guarantee

2 anni / 2 years

# Allsize

# 58P10G

RV.4-12-2023

Descrizione / Description

Misure / Quotes

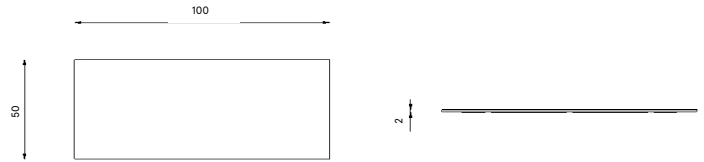

## Caratteristiche / Characteristics

Prolunga aggiuntiva in in gres porcellanato (sp. 6 mm). Utilizzo esclusivo per top in gres (sp. 6 mm). / Additional extension in porcelain stoneware (th. mm 6). Exclusive use for stoneware tops (th. mm 6).

Design / Design

Alberto Lievore | 2023

Dimensioni / Dimensions

50 x 101

Esterno / Outdoor

Si / Yes

Struttura / Structure

Alluminio pressofuso, estruso con piano in gres porcellanato / Die-cast, extruded aluminium with porcelain stoneware top

Elementi plastici / Plastic elements

Polipropilene ed elastomero termoplastico / Polypropylene and thermoplastic elastomer

Finitura / Paint finishes

Verniciatura polveri poliesteri o poliuretaniche / Paint finish with polyester or polyurethane powders

Impilabilità / Stackability

No

Viterie assemblaggio / Assembly screws

Acciaio inox / Stainless steel

Peso netto singolo pezzo / Net weight

12 kg

Pezzi per scatola / Units per package

1 assemblato / 1 assembled

Dimensione e volume imballo / Packaging dimension and volume

116 x 63 x 11 cm 0.080 m<sup>3</sup>

Peso lordo imballo / Gross weight package

14 kg

Garanzia / Quality guarantee

2 anni / 2 years

# Allsize

# 59Q099A

RV.4-12-2023

Descrizione / Description

Misure / Quotes

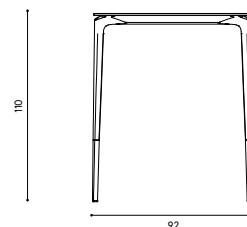
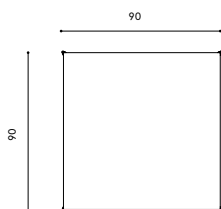

Caratteristiche / Characteristics

Tavolo alto quadrato in alluminio verniciato / Square table in painted aluminium

Design / Design

Alberto Lievore | 2019

Dimensioni / Dimensions

91 x 91 x 110 h

Esterno / Outdoor

Si / Yes

Struttura / Structure

Alluminio pressofuso, estruso e laminato / Die-cast, extruded and laminated aluminium

Elementi plastici / Plastic elements

Polipropilene ed elastomero termoplastico / Polypropylene and thermoplastic elastomer

Finitura / Paint finishes

Verniciatura polveri poliuretaniche ed effetto puntinato / Polyurethane powder coating with and speckled aluminium effect

Impilabilità / Stackability

No

Viterie assemblaggio / Assembly screws

Acciaio inox / Stainless steel

Peso netto singolo pezzo / Net weight

31.5 / 37.5 kg

Pezzi per scatola / Units per package

1 disassemblato / 1 disassembled

Dimensione e volume imballo / Packaging dimension and volume

144 x 110 x 26 cm 0.412 m<sup>3</sup>

Peso lordo imballo / Gross weight package

26 kg

Garanzia / Quality guarantee

2 anni / 2 years

# Allsize

# 59Q099S

RV.4-12-2023

Descrizione / Description

Misure / Quotes

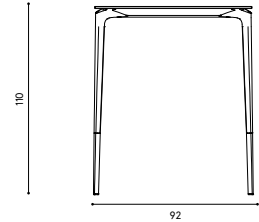
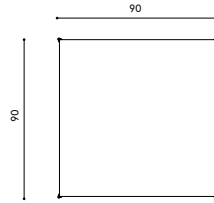

## Caratteristiche / Characteristics

Tavolo alto quadrato in alluminio verniciato con piano in alluminio puntinato / Square table in painted aluminium with top in speckled aluminium

Design / Design	Alberto Lievore   2019
Dimensioni / Dimensions	91 x 91 x 110 h
Esterno / Outdoor	Si / Yes
Struttura / Structure	Alluminio pressofuso, estruso e laminato / Die-cast, extruded and laminated aluminium
Elementi plastici / Plastic elements	Polipropilene ed elastomero termoplastico / Polypropylene and thermoplastic elastomer
Finitura / Paint finishes	Verniciatura polveri poliuretatiche ed effetto puntinato / Polyurethane powder coating with and speckled aluminium effect
Impilabilità / Stackability	No
Viterie assemblaggio / Assembly screws	Acciaio inox / Stainless steel
Peso netto singolo pezzo / Net weight	31.5 / 37.5 kg
Pezzi per scatola / Units per package	1 disassemblato / 1 disassembled
Dimensione e volume imballo / Packaging dimension and volume	144 x 110 x 26 cm 0.412 m <sup>3</sup>
Peso lordo imballo / Gross weight package	26 kg
Garanzia / Quality guarantee	2 anni / 2 years

# Allsize

# 59Q099G

RV.4-12-2023

Descrizione / Description

Misure / Quotes

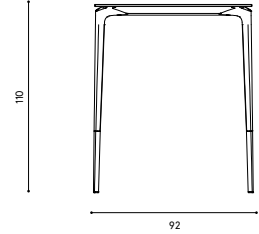
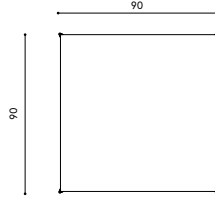

## Caratteristiche / Characteristics

Tavolo alto quadrato in alluminio verniciato con piano in gres porcellanato / Square table in painted aluminium with top in porcelain stoneware

Design / Design

Alberto Lievore | 2019

Dimensioni / Dimensions

91 x 91 x 110 h

Esterno / Outdoor

Si / Yes

Struttura / Structure

Alluminio pressofuso, estruso e laminato / Die-cast, extruded and laminated aluminium

Elementi plastici / Plastic elements

Polipropilene ed elastomero termoplastico / Polypropylene and thermoplastic elastomer

Finitura / Paint finishes

Verniciatura polveri poliuretatiche ed effetto puntinato / Polyurethane powder coating with and speckled aluminium effect

Impilabilità / Stackability

No

Viterie assemblaggio / Assembly screws

Acciaio inox / Stainless steel

Peso netto singolo pezzo / Net weight

31.5 / 37.5 kg

Pezzi per scatola / Units per package

1 disassemblato / 1 disassembled

Dimensione e volume imballo / Packaging dimension and volume

144 x 110 x 26 cm 0.412 m<sup>3</sup>

Peso lordo imballo / Gross weight package

32 kg

Garanzia / Quality guarantee

2 anni / 2 years

# Allsize

# 59R138A

RV.4-12-2023

Descrizione / Description

Misure / Quotes

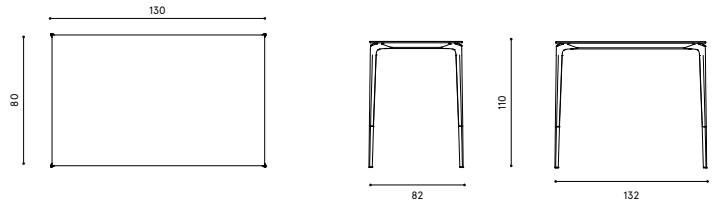

Caratteristiche / Characteristics

Tavolo alto rettangolare in alluminio verniciato / Rectangular bar table in painted aluminium

Design / Design

Alberto Lievore | 2019

Dimensioni / Dimensions

131 x 81 x 110 h

Esterno / Outdoor

Si / Yes

Struttura / Structure

Alluminio pressofuso, estruso e laminato / Die-cast, extruded and laminated aluminium

Elementi plastici / Plastic elements

Polipropilene ed elastomero termoplastico / Polypropylene and thermoplastic elastomer

Finitura / Paint finishes

Verniciatura polveri poliuretaniche ed effetto puntinato / Polyurethane powder coating with and speckled aluminium effect

Impilabilità / Stackability

No

Viterie assemblaggio / Assembly screws

Acciaio inox / Stainless steel

Peso netto singolo pezzo / Net weight

31.5 / 37.5 kg

Pezzi per scatola / Units per package

1 disassemblato / 1 disassembled

Dimensione e volume imballo / Packaging dimension and volume

183 x 110 x 22 cm 0.442 m<sup>3</sup>

Peso lordo imballo / Gross weight package

30 kg

Garanzia / Quality guarantee

2 anni / 2 years

# Allsize

# 59R138S

RV.4-12-2023

Descrizione / Description

Misure / Quotes

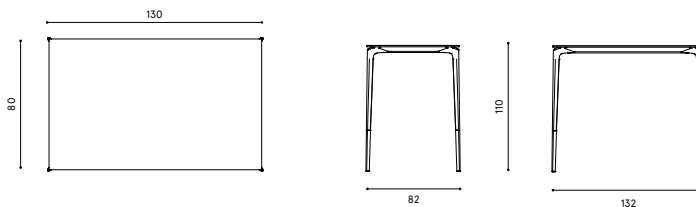

## Caratteristiche / Characteristics

Tavolo alto rettangolare in alluminio verniciato con piano in alluminio puntinato / Rectangular bar table in painted aluminium with top in speckled aluminium

Design / Design

Alberto Lievore | 2019

Dimensioni / Dimensions

131 x 81 x 110 h

Esterno / Outdoor

Si / Yes

Struttura / Structure

Alluminio pressofuso, estruso e laminato / Die-cast, extruded and laminated aluminium

Elementi plastici / Plastic elements

Polipropilene ed elastomero termoplastico / Polypropylene and thermoplastic elastomer

Finitura / Paint finishes

Verniciatura polveri poliuretaniche ed effetto puntinato / Polyurethane powder coating with and speckled aluminium effect

Impilabilità / Stackability

No

Viterie assemblaggio / Assembly screws

Acciaio inox / Stainless steel

Peso netto singolo pezzo / Net weight

31.5 / 37.5 kg

Pezzi per scatola / Units per package

1 disassemblato / 1 disassembled

Dimensione e volume imballo / Packaging dimension and volume

183 x 110 x 22 cm 0.442 m<sup>3</sup>

Peso lordo imballo / Gross weight package

30 kg

Garanzia / Quality guarantee

2 anni / 2 years

# Allsize

# 59R138G

RV.4-12-2023

Descrizione / Description

Misure / Quotes

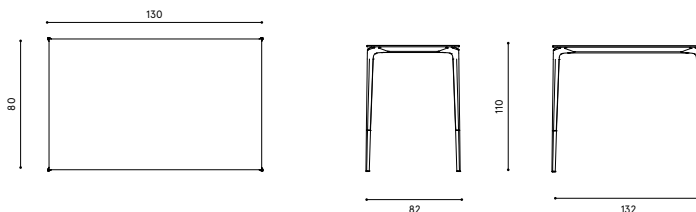
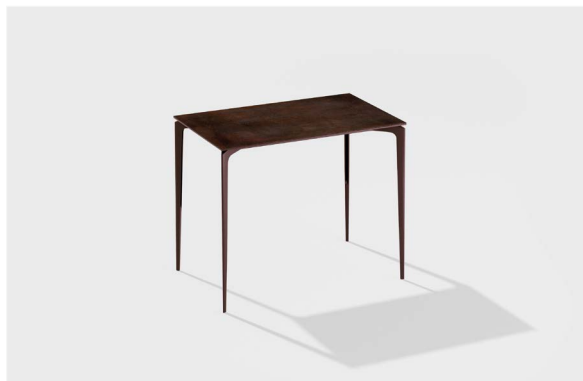

## Caratteristiche / Characteristics

Tavolo alto rettangolare in alluminio verniciato con piano in gres porcellanato / Rectangular bar table in painted aluminium with top in porcelain stoneware

Design / Design

Alberto Lievore | 2019

Dimensioni / Dimensions

131 x 81 x 110 h

Esterno / Outdoor

Sì / Yes

Struttura / Structure

Alluminio pressofuso, estruso e laminato / Die-cast, extruded and laminated aluminium

Elementi plastici / Plastic elements

Polipropilene ed elastomero termoplastico / Polypropylene and thermoplastic elastomer

Finitura / Paint finishes

Verniciatura polveri poliuretatiche ed effetto puntinato / Polyurethane powder coating with and speckled aluminium effect

Impilabilità / Stackability

No

Viterie assemblaggio / Assembly screws

Acciaio inox / Stainless steel

Peso netto singolo pezzo / Net weight

31.5 / 37.5 kg

Pezzi per scatola / Units per package

1 disassemblato / 1 disassembled

Dimensione e volume imballo / Packaging dimension and volume

183 x 110 x 22 cm 0.442 m<sup>3</sup>

Peso lordo imballo / Gross weight package

38 kg

Garanzia / Quality guarantee

2 anni / 2 years



# Allsize

# 59R134A

RV.4-12-2023

Descrizione / Description

Misure / Quotes

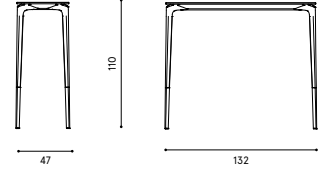
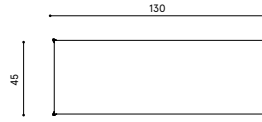

## Caratteristiche / Characteristics

Tavolo alto rettangolare in alluminio verniciato / Rectangular bar table in painted aluminium

Design / Design

Alberto Lievore | 2019

Dimensioni / Dimensions

131 x 46 x 110 h

Esterno / Outdoor

Si / Yes

Struttura / Structure

Alluminio pressofuso, estruso e laminato / Die-cast, extruded and laminated aluminium

Elementi plastici / Plastic elements

Polipropilene ed elastomero termoplastico / Polypropylene and thermoplastic elastomer

Finitura / Paint finishes

Verniciatura polveri poliuretaniche ed effetto puntinato / Polyurethane powder coating with and speckled aluminium effect

Impilabilità / Stackability

No

Viterie assemblaggio / Assembly screws

Acciaio inox / Stainless steel

Peso netto singolo pezzo / Net weight

31.5 / 37.5 kg

Pezzi per scatola / Units per package

1 disassemblato / 1 disassembled

Dimensione e volume imballo / Packaging dimension and volume

183 x 110 x 22 cm 0.442 m<sup>3</sup>

Peso lordo imballo / Gross weight package

25 kg

Garanzia / Quality guarantee

2 anni / 2 years

# Allsize

# 59R134S

RV.4-12-2023

Descrizione / Description

Misure / Quotes

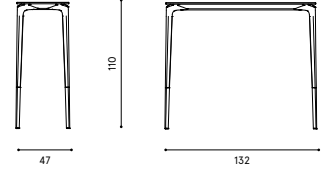
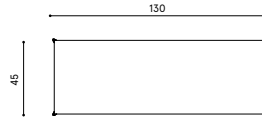

## Caratteristiche / Characteristics

Tavolo alto rettangolare in alluminio verniciato con piano in alluminio puntinato / Rectangular bar table in painted aluminium with top in speckled aluminium

Design / Design

Alberto Lievore | 2019

Dimensioni / Dimensions

131 x 46 x 110 h

Esterno / Outdoor

Si / Yes

Struttura / Structure

Alluminio pressofuso, estruso e laminato / Die-cast, extruded and laminated aluminium

Elementi plastici / Plastic elements

Polipropilene ed elastomero termoplastico / Polypropylene and thermoplastic elastomer

Finitura / Paint finishes

Verniciatura polveri poliuretatiche ed effetto puntinato / Polyurethane powder coating with and speckled aluminium effect

Impilabilità / Stackability

No

Viterie assemblaggio / Assembly screws

Acciaio inox / Stainless steel

Peso netto singolo pezzo / Net weight

31.5 / 37.5 kg

Pezzi per scatola / Units per package

1 disassemblato / 1 disassembled

Dimensione e volume imballo / Packaging dimension and volume

183 x 110 x 22 cm 0.442 m<sup>3</sup>

Peso lordo imballo / Gross weight package

25 kg

Garanzia / Quality guarantee

2 anni / 2 years

# Allsize

# 59R134G

RV.4-12-2023

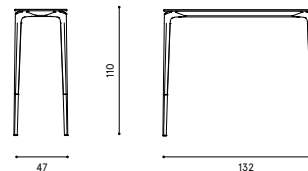
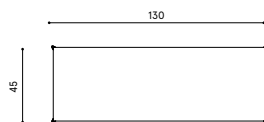
**Descrizione / Description****Misure / Quotes****Caratteristiche / Characteristics**

Tavolo alto rettangolare in alluminio verniciato con piano in gres porcellanato / Rectangular bar table in painted aluminium with top in porcelain stoneware

Design / Design

Alberto Lievore | 2019

Dimensioni / Dimensions

131 x 46 x 110 h

Esterno / Outdoor

Sì / Yes

Struttura / Structure

Alluminio pressofuso, estruso e laminato / Die-cast, extruded and laminated aluminium

Elementi plastici / Plastic elements

Polipropilene ed elastomero termoplastico / Polypropylene and thermoplastic elastomer

Finitura / Paint finishes

Verniciatura polveri poliuretatiche ed effetto puntinato / Polyurethane powder coating with and speckled aluminium effect

Impilabilità / Stackability

No

Viterie assemblaggio / Assembly screws

Acciaio inox / Stainless steel

Peso netto singolo pezzo / Net weight

31.5 / 37.5 kg

Pezzi per scatola / Units per package

1 disassemblato / 1 disassembled

Dimensione e volume imballo / Packaging dimension and volume

183 x 110 x 22 cm 0.442 m<sup>3</sup>

Peso lordo imballo / Gross weight package

30 kg

Garanzia / Quality guarantee

2 anni / 2 years

# Allsize

# 59R207A

RV.4-12-2023

Descrizione / Description

Misure / Quotes

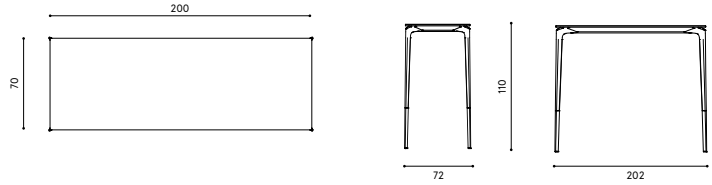

## Caratteristiche / Characteristics

Tavolo alto rettangolare in alluminio verniciato / Rectangular bar table in painted aluminium

Design / Design

Alberto Lievore | 2019

Dimensioni / Dimensions

201 x 71 x 110 h

Esterno / Outdoor

Si / Yes

Struttura / Structure

Alluminio pressofuso, estruso e laminato / Die-cast, extruded and laminated aluminium

Elementi plastici / Plastic elements

Polipropilene ed elastomero termoplastico / Polypropylene and thermoplastic elastomer

Finitura / Paint finishes

Verniciatura polveri poliuretaniche ed effetto puntinato / Polyurethane powder coating with and speckled aluminium effect

Impilabilità / Stackability

No

Viterie assemblaggio / Assembly screws

Acciaio inox / Stainless steel

Peso netto singolo pezzo / Net weight

31.5 / 37.5 kg

Pezzi per scatola / Units per package

1 disassemblato / 1 disassembled

Dimensione e volume imballo / Packaging dimension and volume

252 x 116 x 20 cm 0.585 m<sup>3</sup>

Peso lordo imballo / Gross weight package

38 kg

Garanzia / Quality guarantee

2 anni / 2 years

# Allsize

# 59R207S

RV.4-12-2023

Descrizione / Description

Misure / Quotes

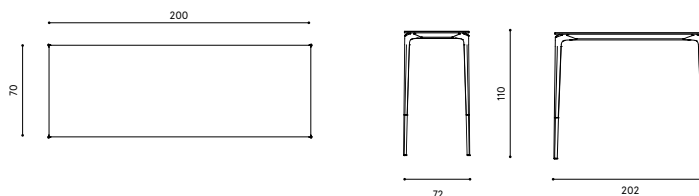

## Caratteristiche / Characteristics

Tavolo alto rettangolare in alluminio verniciato con piano in alluminio puntinato / Rectangular bar table in painted aluminium with top in speckled aluminium

Design / Design

Alberto Lievore | 2019

Dimensioni / Dimensions

201 x 71 x 110 h

Esterno / Outdoor

Si / Yes

Struttura / Structure

Alluminio pressofuso, estruso e laminato / Die-cast, extruded and laminated aluminium

Elementi plastici / Plastic elements

Polipropilene ed elastomero termoplastico / Polypropylene and thermoplastic elastomer

Finitura / Paint finishes

Verniciatura polveri poliuretatiche ed effetto puntinato / Polyurethane powder coating with and speckled aluminium effect

Impilabilità / Stackability

No

Viterie assemblaggio / Assembly screws

Acciaio inox / Stainless steel

Peso netto singolo pezzo / Net weight

31.5 / 37.5 kg

Pezzi per scatola / Units per package

1 disassemblato / 1 disassembled

Dimensione e volume imballo / Packaging dimension and volume

252 x 116 x 20 cm 0.585 m<sup>3</sup>

Peso lordo imballo / Gross weight package

38 kg

Garanzia / Quality guarantee

2 anni / 2 years

# Allsize

# 59R207G

RV.4-12-2023

Descrizione / Description

Misure / Quotes

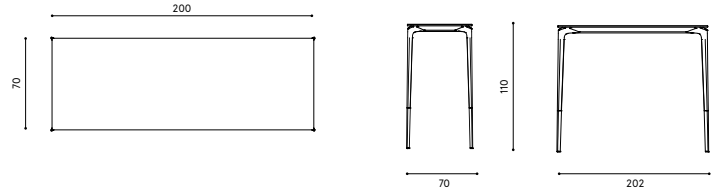

## Caratteristiche / Characteristics

Tavolo alto rettangolare in alluminio verniciato con piano in gres porcellanato / Rectangular bar table in painted aluminium with top in porcelain stoneware

Design / Design	Alberto Lievore   2019
Dimensioni / Dimensions	201 x 71 x 110 h
Esterno / Outdoor	Si / Yes
Struttura / Structure	Alluminio pressofuso, estruso e laminato / Die-cast, extruded and laminated aluminium
Elementi plastici / Plastic elements	Polipropilene ed elastomero termoplastico / Polypropylene and thermoplastic elastomer
Finitura / Paint finishes	Verniciatura polveri poliuretatiche ed effetto puntinato / Polyurethane powder coating with and speckled aluminium effect
Impilabilità / Stackability	No
Viterie assemblaggio / Assembly screws	Acciaio inox / Stainless steel
Peso netto singolo pezzo / Net weight	31.5 / 37.5 kg
Pezzi per scatola / Units per package	1 disassemblato / 1 disassembled
Dimensione e volume imballo / Packaging dimension and volume	252 x 116 x 20 cm 0.585 m <sup>3</sup>
Peso lordo imballo / Gross weight package	48 kg
Garanzia / Quality guarantee	2 anni / 2 years

# Allsize

# 59R204A

RV.4-12-2023

Descrizione / Description

Misure / Quotes

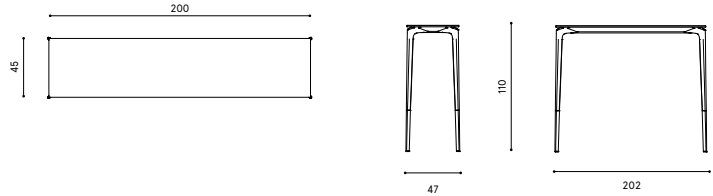

## Caratteristiche / Characteristics

Tavolo alto rettangolare in alluminio verniciato / Rectangular bar table in painted aluminium

Design / Design

Alberto Lievore | 2019

Dimensioni / Dimensions

201 x 46 x 110 h

Esterno / Outdoor

Si / Yes

Struttura / Structure

Alluminio pressofuso, estruso e laminato / Die-cast, extruded and laminated aluminium

Elementi plastici / Plastic elements

Polipropilene ed elastomero termoplastico / Polypropylene and thermoplastic elastomer

Finitura / Paint finishes

Verniciatura polveri poliuretatiche ed effetto puntinato / Polyurethane powder coating with and speckled aluminium effect

Impilabilità / Stackability

No

Viterie assemblaggio / Assembly screws

Acciaio inox / Stainless steel

Peso netto singolo pezzo / Net weight

31.5 / 37.5 kg

Pezzi per scatola / Units per package

1 disassemblato / 1 disassembled

Dimensione e volume imballo / Packaging dimension and volume

252 x 116 x 20 cm 0.585 m<sup>3</sup>

Peso lordo imballo / Gross weight package

33 kg

Garanzia / Quality guarantee

2 anni / 2 years

## Descrizione / Description

## Misure / Quotes

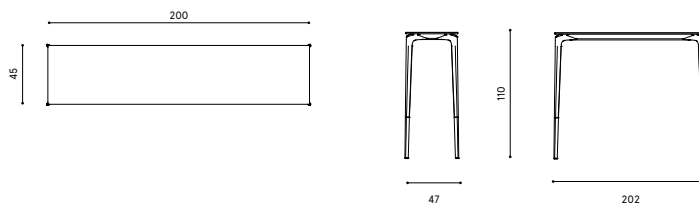

## Caratteristiche / Characteristics

Tavolo alto rettangolare in alluminio verniciato con piano in alluminio puntinato / Rectangular bar table in painted aluminium with top in speckled aluminium

## Design / Design

Alberto Lievore | 2019

## Dimensioni / Dimensions

201 x 46 x 110 h

## Esterno / Outdoor

Si / Yes

## Struttura / Structure

Alluminio pressofuso, estruso e laminato / Die-cast, extruded and laminated aluminium

## Elementi plastici / Plastic elements

Polipropilene ed elastomero termoplastico / Polypropylene and thermoplastic elastomer

## Finitura / Paint finishes

Verniciatura polveri poliuretatiche ed effetto puntinato / Polyurethane powder coating with and speckled aluminium effect

## Impilabilità / Stackability

No

## Viterie assemblaggio / Assembly screws

Acciaio inox / Stainless steel

## Peso netto singolo pezzo / Net weight

31.5 / 37.5 kg

## Pezzi per scatola / Units per package

1 disassemblato / 1 disassembled

## Dimensione e volume imballo / Packaging dimension and volume

252 x 116 x 20 cm 0.585 m<sup>3</sup>

## Peso lordo imballo / Gross weight package

33 kg

## Garanzia / Quality guarantee

2 anni / 2 years



# Allsize

# 59R204G

RV.4-12-2023

Descrizione / Description

Misure / Quotes

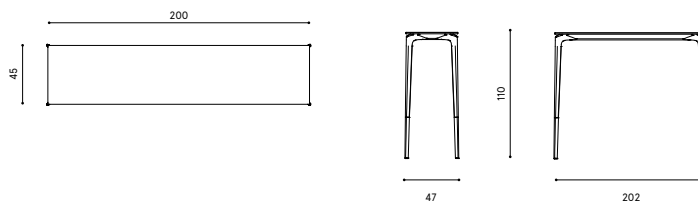

## Caratteristiche / Characteristics

Tavolo alto rettangolare in alluminio verniciato con piano in gres porcellanato / Rectangular bar table in painted aluminium with top in porcelain stoneware

Design / Design

Alberto Lievore | 2019

Dimensioni / Dimensions

201 x 46 x 110 h

Esterno / Outdoor

Si / Yes

Struttura / Structure

Alluminio pressofuso, estruso e laminato / Die-cast, extruded and laminated aluminium

Elementi plastici / Plastic elements

Polipropilene ed elastomero termoplastico / Polypropylene and thermoplastic elastomer

Finitura / Paint finishes

Verniciatura polveri poliuretatiche ed effetto puntinato / Polyurethane powder coating with and speckled aluminium effect

Impilabilità / Stackability

No

Viterie assemblaggio / Assembly screws

Acciaio inox / Stainless steel

Peso netto singolo pezzo / Net weight

31.5 / 37.5 kg

Pezzi per scatola / Units per package

1 disassemblato / 1 disassembled

Dimensione e volume imballo / Packaging dimension and volume

252 x 116 x 20 cm 0.585 m<sup>3</sup>

Peso lordo imballo / Gross weight package

40 kg

Garanzia / Quality guarantee

2 anni / 2 years

# Allsize

# 57R09A

RV.4-12-2023

Descrizione / Description

Misure / Quotes

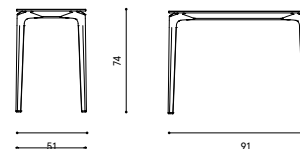
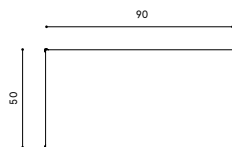

Caratteristiche / Characteristics

Consolle in alluminio verniciato / Console in painted aluminium

Design / Design

Alberto Lievore | 2019

Dimensioni / Dimensions

91 x 51 x 74 h

Esterno / Outdoor

Sì / Yes

Struttura / Structure

Alluminio pressofuso, estruso e laminato / Die-cast, extruded and laminated aluminium

Elementi plastici / Plastic elements

Polipropilene ed elastomero termoplastico / Polypropylene and thermoplastic elastomer

Finitura / Paint finishes

Verniciatura polveri poliuretaniche ed effetto puntinato / Polyurethane powder coating with and speckled aluminium effect

Impilabilità / Stackability

No

Viterie assemblaggio / Assembly screws

Acciaio inox / Stainless steel

Peso netto singolo pezzo / Net weight

31.5 / 37.5 kg

Pezzi per scatola / Units per package

1 disassemblato / 1 disassembled

Dimensione e volume imballo / Packaging dimension and volume

144 x 110 x 26 cm 0.412 m<sup>3</sup>

Peso lordo imballo / Gross weight package

21 kg

Garanzia / Quality guarantee

2 anni / 2 years

# Allsize

# 57R09S

RV.4-12-2023

Descrizione / Description

Misure / Quotes

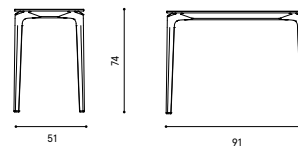
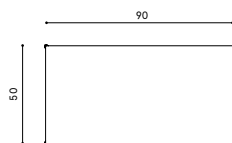

## Caratteristiche / Characteristics

Consolle in alluminio verniciato con piano in alluminio puntinato / Console in painted aluminium with top in speckled aluminium

Design / Design

Alberto Lievore | 2019

Dimensioni / Dimensions

91 x 51 x 74 h

Esterno / Outdoor

Si / Yes

Struttura / Structure

Alluminio pressofuso, estruso e laminato / Die-cast, extruded and laminated aluminium

Elementi plastici / Plastic elements

Polipropilene ed elastomero termoplastico / Polypropylene and thermoplastic elastomer

Finitura / Paint finishes

Verniciatura polveri poliuretatiche ed effetto puntinato / Polyurethane powder coating with and speckled aluminium effect

Impilabilità / Stackability

No

Viterie assemblaggio / Assembly screws

Acciaio inox / Stainless steel

Peso netto singolo pezzo / Net weight

31.5 / 37.5 kg

Pezzi per scatola / Units per package

1 disassemblato / 1 disassembled

Dimensione e volume imballo / Packaging dimension and volume

144 x 110 x 26 cm 0.412 m<sup>3</sup>

Peso lordo imballo / Gross weight package

21 kg

Garanzia / Quality guarantee

2 anni / 2 years

# Allsize

# 57R09G

RV.4-12-2023

Descrizione / Description

Misure / Quotes

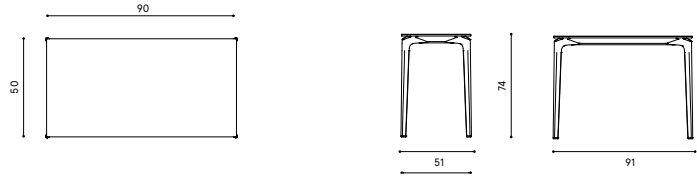

## Caratteristiche / Characteristics

Consolle in alluminio verniciato con piano in gres porcellanato / Console in painted aluminium with top in porcelain stoneware

Design / Design

Alberto Lievore | 2019

Dimensioni / Dimensions

91 x 51 x 74 h

Esterno / Outdoor

Si / Yes

Struttura / Structure

Alluminio pressofuso, estruso e laminato / Die-cast, extruded and laminated aluminium

Elementi plastici / Plastic elements

Polipropilene ed elastomero termoplastico / Polypropylene and thermoplastic elastomer

Finitura / Paint finishes

Verniciatura polveri poliuretaniche ed effetto puntinato / Polyurethane powder coating with and speckled aluminium effect

Impilabilità / Stackability

No

Viterie assemblaggio / Assembly screws

Acciaio inox / Stainless steel

Peso netto singolo pezzo / Net weight

31.5 / 37.5 kg

Pezzi per scatola / Units per package

1 disassemblato / 1 disassembled

Dimensione e volume imballo / Packaging dimension and volume

144 x 110 x 26 cm 0.412 m<sup>3</sup>

Peso lordo imballo / Gross weight package

24 kg

Garanzia / Quality guarantee

2 anni / 2 years

# Allsize

# 57R10A

RV.4-12-2023

Descrizione / Description

Misure / Quotes

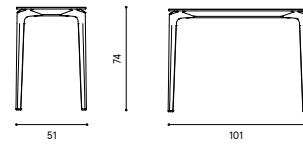
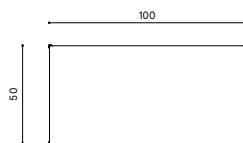

Caratteristiche / Characteristics

Consolle in alluminio verniciato / Console in painted aluminium

Design / Design	Alberto Lievore   2019
Dimensioni / Dimensions	101 x 51 x 74 h
Esterno / Outdoor	Si / Yes
Struttura / Structure	Alluminio pressofuso, estruso e laminato / Die-cast, extruded and laminated aluminium
Elementi plastici / Plastic elements	Polipropilene ed elastomero termoplastico / Polypropylene and thermoplastic elastomer
Finitura / Paint finishes	Verniciatura polveri poliuretatiche ed effetto puntinato / Polyurethane powder coating with and speckled aluminium effect
Impilabilità / Stackability	No
Viterie assemblaggio / Assembly screws	Acciaio inox / Stainless steel
Peso netto singolo pezzo / Net weight	31.5 / 37.5 kg
Pezzi per scatola / Units per package	1 disassemblato / 1 disassembled
Dimensione e volume imballo / Packaging dimension and volume	63 x 113 x 20 cm 0.142 m <sup>3</sup>
Peso lordo imballo / Gross weight package	21 kg
Garanzia / Quality guarantee	2 anni / 2 years

## Descrizione / Description

## Misure / Quotes

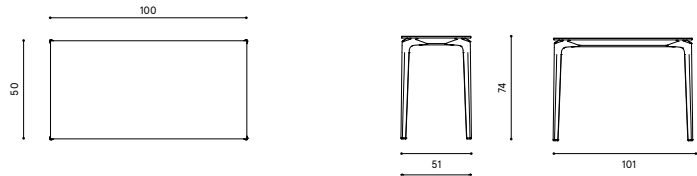

## Caratteristiche / Characteristics

Consolle in alluminio verniciato con piano in alluminio puntinato / Console in painted with top in speckled aluminium

## Design / Design

Alberto Lievore | 2019

## Dimensioni / Dimensions

101 x 51 x 74 h

## Esterno / Outdoor

Si / Yes

## Struttura / Structure

Alluminio pressofuso, estruso e laminato / Die-cast, extruded and laminated aluminium

## Elementi plastici / Plastic elements

Polipropilene ed elastomero termoplastico / Polypropylene and thermoplastic elastomer

## Finitura / Paint finishes

Verniciatura polveri poliuretaniche ed effetto puntinato / Polyurethane powder coating with and speckled aluminium effect

## Impilabilità / Stackability

No

## Viterie assemblaggio / Assembly screws

Acciaio inox / Stainless steel

## Peso netto singolo pezzo / Net weight

31.5 / 37.5 kg

## Pezzi per scatola / Units per package

1 disassemblato / 1 disassembled

## Dimensione e volume imballo / Packaging dimension and volume

63 x 113 x 20 cm 0.142 m<sup>3</sup>

## Peso lordo imballo / Gross weight package

21 kg

## Garanzia / Quality guarantee

2 anni / 2 years

# Allsize

# 57R10G

RV.4-12-2023

Descrizione / Description

Misure / Quotes

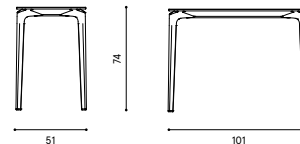
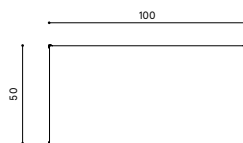
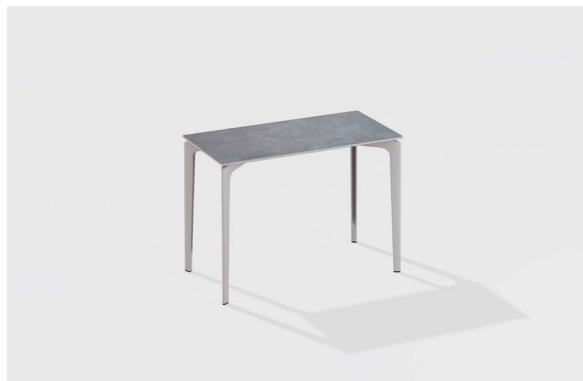

## Caratteristiche / Characteristics

Consolle in alluminio verniciato con piano in gres porcellanato / Console in painted aluminium with top in porcelain stoneware

Design / Design	Alberto Lievore   2019
Dimensioni / Dimensions	101 x 51 x 74 h
Esterno / Outdoor	Si / Yes
Struttura / Structure	Alluminio pressofuso, estruso e laminato / Die-cast, extruded and laminated aluminium
Elementi plastici / Plastic elements	Polipropilene ed elastomero termoplastico / Polypropylene and thermoplastic elastomer
Finitura / Paint finishes	Verniciatura polveri poliuretatiche ed effetto puntinato / Polyurethane powder coating with and speckled aluminium effect
Impilabilità / Stackability	No
Viterie assemblaggio / Assembly screws	Acciaio inox / Stainless steel
Peso netto singolo pezzo / Net weight	31.5 / 37.5 kg
Pezzi per scatola / Units per package	1 disassemblato / 1 disassembled
Dimensione e volume imballo / Packaging dimension and volume	63 x 113 x 20 cm    0.142 m <sup>3</sup>
Peso lordo imballo / Gross weight package	25 kg
Garanzia / Quality guarantee	2 anni / 2 years

# Allsize

# 56Q05A

RV.4-12-2023

Descrizione / Description

Misure / Quotes

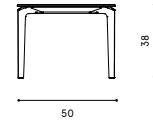
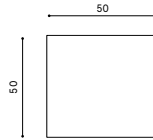

## Caratteristiche / Characteristics

Tavolo basso quadrato in alluminio verniciato / Low square table in painted aluminium

Design / Design

Alberto Lievore | 2019

Dimensioni / Dimensions

50 x 50 x 38 h

Esterno / Outdoor

Si / Yes

Struttura / Structure

Alluminio pressofuso, estruso e laminato / Die-cast, extruded and laminated aluminium

Elementi plastici / Plastic elements

Polipropilene ed elastomero termoplastico / Polypropylene and thermoplastic elastomer

Finitura / Paint finishes

Verniciatura polveri poliuretatiche ed effetto puntinato / Polyurethane powder coating with and speckled aluminium effect

Impilabilità / Stackability

No

Viterie assemblaggio / Assembly screws

Acciaio inox / Stainless steel

Peso netto singolo pezzo / Net weight

31.5 / 37.5 kg

Pezzi per scatola / Units per package

1 disassemblato / 1 disassembled

Dimensione e volume imballo / Packaging dimension and volume

63 x 63 x 20 cm 0.079 m<sup>3</sup>

Peso lordo imballo / Gross weight package

14 kg

Garanzia / Quality guarantee

2 anni / 2 years



## Descrizione / Description

## Misure / Quotes

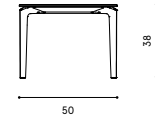
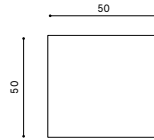

## Caratteristiche / Characteristics

Tavolo basso quadrato in alluminio verniciato con piano in alluminio puntinato / Low square table in painted aluminium with top in speckled aluminium

## Design / Design

Alberto Lievore | 2019

## Dimensioni / Dimensions

50 x 50 x 38 h

## Esterno / Outdoor

Si / Yes

## Struttura / Structure

Alluminio pressofuso, estruso e laminato / Die-cast, extruded and laminated aluminium

## Elementi plastici / Plastic elements

Polipropilene ed elastomero termoplastico / Polypropylene and thermoplastic elastomer

## Finitura / Paint finishes

Verniciatura polveri poliuretatiche ed effetto puntinato / Polyurethane powder coating with and speckled aluminium effect

## Impilabilità / Stackability

No

## Viterie assemblaggio / Assembly screws

Acciaio inox / Stainless steel

## Peso netto singolo pezzo / Net weight

31.5 / 37.5 kg

## Pezzi per scatola / Units per package

1 disassemblato / 1 disassembled

## Dimensione e volume imballo / Packaging dimension and volume

63 x 63 x 20 cm 0.079 m<sup>3</sup>

## Peso lordo imballo / Gross weight package

14 kg

## Garanzia / Quality guarantee

2 anni / 2 years

## Descrizione / Description

## Misure / Quotes

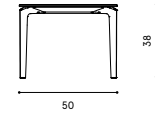
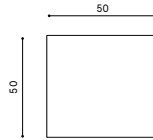

## Caratteristiche / Characteristics

Tavolo basso quadrato in alluminio verniciato con piano in gres porcellanato / Low square table in painted aluminium with top in porcelain stoneware

## Design / Design

Alberto Lievore | 2019

## Dimensioni / Dimensions

50 x 50 x 38 h

## Esterno / Outdoor

Si / Yes

## Struttura / Structure

Alluminio pressofuso, estruso e laminato / Die-cast, extruded and laminated aluminium

## Elementi plastici / Plastic elements

Polipropilene ed elastomero termoplastico / Polypropylene and thermoplastic elastomer

## Finitura / Paint finishes

Verniciatura polveri poliuretatiche ed effetto puntinato / Polyurethane powder coating with and speckled aluminium effect

## Impilabilità / Stackability

No

## Viterie assemblaggio / Assembly screws

Acciaio inox / Stainless steel

## Peso netto singolo pezzo / Net weight

31.5 / 37.5 kg

## Pezzi per scatola / Units per package

1 disassemblato / 1 disassembled

## Dimensione e volume imballo / Packaging dimension and volume

63 x 63 x 20 cm 0.079 m<sup>3</sup>

## Peso lordo imballo / Gross weight package

16 kg

## Garanzia / Quality guarantee

2 anni / 2 years

# Allsize

# 56R12A

RV.4-12-2023

Descrizione / Description

Misure / Quotes

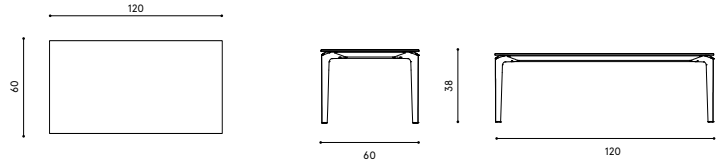

## Caratteristiche / Characteristics

Tavolo basso rettangolare in alluminio verniciato / Low rectangular table in painted aluminium

Design / Design

Alberto Lievore | 2019

Dimensioni / Dimensions

120 x 60 x 38 h

Esterno / Outdoor

Si / Yes

Struttura / Structure

Alluminio pressofuso, estruso e laminato / Die-cast, extruded and laminated aluminium

Elementi plastici / Plastic elements

Polipropilene ed elastomero termoplastico / Polypropylene and thermoplastic elastomer

Finitura / Paint finishes

Verniciatura polveri poliuretaniche ed effetto puntinato / Polyurethane powder coating with and speckled aluminium effect

Impilabilità / Stackability

No

Viterie assemblaggio / Assembly screws

Acciaio inox / Stainless steel

Peso netto singolo pezzo / Net weight

31.5 / 37.5 kg

Pezzi per scatola / Units per package

1 disassemblato / 1 disassembled

Dimensione e volume imballo / Packaging dimension and volume

183 x 110 x 22 cm 0.442 m<sup>3</sup>

Peso lordo imballo / Gross weight package

15 kg

Garanzia / Quality guarantee

2 anni / 2 years

# Allsize

# 56R12S

RV.4-12-2023

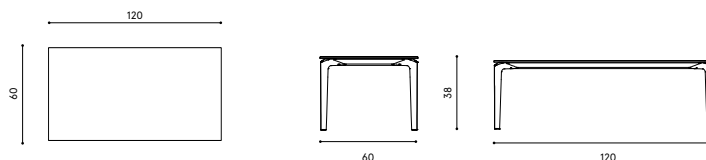
**Descrizione / Description****Misure / Quotes****Caratteristiche / Characteristics**

Tavolo basso rettangolare in alluminio verniciato con piano in alluminio puntinato / Low rectangular table in painted aluminium with top in speckled aluminium

Design / Design

Alberto Lievore | 2019

Dimensioni / Dimensions

120 x 60 x 38 h

Esterno / Outdoor

Sì / Yes

Struttura / Structure

Alluminio pressofuso, estruso e laminato / Die-cast, extruded and laminated aluminium

Elementi plastici / Plastic elements

Polipropilene ed elastomero termoplastico / Polypropylene and thermoplastic elastomer

Finitura / Paint finishes

Verniciatura polveri poliuretatiche ed effetto puntinato / Polyurethane powder coating with speckled aluminium effect

Impilabilità / Stackability

No

Viterie assemblaggio / Assembly screws

Acciaio inox / Stainless steel

Peso netto singolo pezzo / Net weight

31.5 / 37.5 kg

Pezzi per scatola / Units per package

1 disassemblato / 1 disassembled

Dimensione e volume imballo / Packaging dimension and volume

183 x 110 x 22 cm 0.442 m<sup>3</sup>

Peso lordo imballo / Gross weight package

15 kg

Garanzia / Quality guarantee

2 anni / 2 years

# Allsize

# 56R12G

RV.4-12-2023

Descrizione / Description

Misure / Quotes

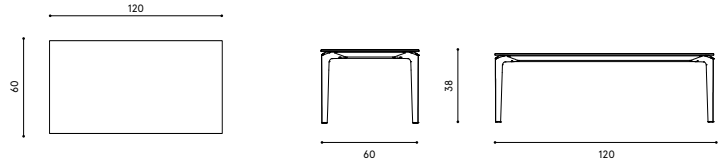

## Caratteristiche / Characteristics

Tavolo basso rettangolare in alluminio verniciato con piano in gres porcellanato / Low rectangular table in painted aluminium with top in porcelain stoneware

Design / Design	Alberto Lievore   2019
Dimensioni / Dimensions	120 x 60 x 38 h
Esterno / Outdoor	Si / Yes
Struttura / Structure	Alluminio pressofuso, estruso e laminato / Die-cast, extruded and laminated aluminium
Elementi plastici / Plastic elements	Polipropilene ed elastomero termoplastico / Polypropylene and thermoplastic elastomer
Finitura / Paint finishes	Verniciatura polveri poliuretatiche ed effetto puntinato / Polyurethane powder coating with and speckled aluminium effect
Impilabilità / Stackability	No
Viterie assemblaggio / Assembly screws	Acciaio inox / Stainless steel
Peso netto singolo pezzo / Net weight	31.5 / 37.5 kg
Pezzi per scatola / Units per package	1 disassemblato / 1 disassembled
Dimensione e volume imballo / Packaging dimension and volume	183 x 110 x 22 cm 0.442 m <sup>3</sup>
Peso lordo imballo / Gross weight package	21 kg
Garanzia / Quality guarantee	2 anni / 2 years

# Allsize

# 56R16A

RV.4-12-2023

Descrizione / Description

Misure / Quotes

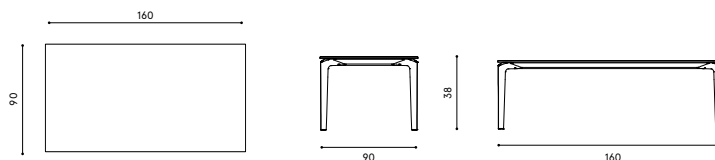

## Caratteristiche / Characteristics

Tavolo basso rettangolare in alluminio verniciato / Low rectangular table in painted aluminium

Design / Design

Alberto Lievore | 2019

Dimensioni / Dimensions

160 x 90 x 38 h

Esterno / Outdoor

Si / Yes

Struttura / Structure

Alluminio pressofuso, estruso e laminato / Die-cast, extruded and laminated aluminium

Elementi plastici / Plastic elements

Polipropilene ed elastomero termoplastico / Polypropylene and thermoplastic elastomer

Finitura / Paint finishes

Verniciatura polveri poliuretaniche ed effetto puntinato / Polyurethane powder coating with and speckled aluminium effect

Impilabilità / Stackability

No

Viterie assemblaggio / Assembly screws

Acciaio inox / Stainless steel

Peso netto singolo pezzo / Net weight

31.5 / 37.5 kg

Pezzi per scatola / Units per package

1 disassemblato / 1 disassembled

Dimensione e volume imballo / Packaging dimension and volume

187 x 110 x 22 cm 0.453 m<sup>3</sup>

Peso lordo imballo / Gross weight package

21 kg

Garanzia / Quality guarantee

2 anni / 2 years

# Allsize

# 56R16S

RV.4-12-2023

Descrizione / Description

Misure / Quotes

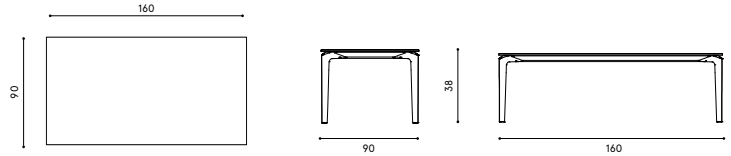

## Caratteristiche / Characteristics

Tavolo basso rettangolare in alluminio verniciato con piano in alluminio puntinato / Low rectangular table in painted aluminium with top in speckled aluminium

Design / Design

Alberto Lievore | 2019

Dimensioni / Dimensions

160 x 90 x 38 h

Esterno / Outdoor

Si / Yes

Struttura / Structure

Alluminio pressofuso, estruso e laminato / Die-cast, extruded and laminated aluminium

Elementi plastici / Plastic elements

Polipropilene ed elastomero termoplastico / Polypropylene and thermoplastic elastomer

Finitura / Paint finishes

Verniciatura polveri poliuretaniche ed effetto puntinato / Polyurethane powder coating with and speckled aluminium effect

Impilabilità / Stackability

No

Viterie assemblaggio / Assembly screws

Acciaio inox / Stainless steel

Peso netto singolo pezzo / Net weight

31.5 / 37.5 kg

Pezzi per scatola / Units per package

1 disassemblato / 1 disassembled

Dimensione e volume imballo / Packaging dimension and volume

187 x 110 x 22 cm 0.453 m<sup>3</sup>

Peso lordo imballo / Gross weight package

21 kg

Garanzia / Quality guarantee

2 anni / 2 years

# Allsize

# 56R16G

RV.4-12-2023

Descrizione / Description

Misure / Quotes

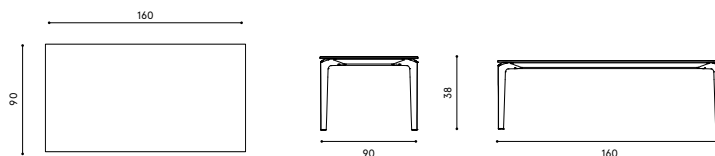

## Caratteristiche / Characteristics

Tavolo basso rettangolare in alluminio verniciato con piano in gres porcellanato / Low rectangular table in painted aluminium with top in porcelain stoneware

Design / Design

Alberto Lievore | 2019

Dimensioni / Dimensions

160 x 90 x 38 h

Esterno / Outdoor

Si / Yes

Struttura / Structure

Alluminio pressofuso, estruso e laminato / Die-cast, extruded and laminated aluminium

Elementi plastici / Plastic elements

Polipropilene ed elastomero termoplastico / Polypropylene and thermoplastic elastomer

Finitura / Paint finishes

Verniciatura polveri poliuretatiche ed effetto puntinato / Polyurethane powder coating with and speckled aluminium effect

Impilabilità / Stackability

No

Viterie assemblaggio / Assembly screws

Acciaio inox / Stainless steel

Peso netto singolo pezzo / Net weight

31.5 / 37.5 kg

Pezzi per scatola / Units per package

1 disassemblato / 1 disassembled

Dimensione e volume imballo / Packaging dimension and volume

187 x 110 x 22 cm 0.453 m<sup>3</sup>

Peso lordo imballo / Gross weight package

32 kg

Garanzia / Quality guarantee

2 anni / 2 years



## По вопросам продаж и поддержки обращайтесь:

Алматы (7273)495-231  
Ангарск (3955)60-70-56  
Архангельск (8182)63-90-72  
Астрахань (8512)99-46-04  
Барнаул (3852)73-04-60  
Белгород (4722)40-23-64  
Благовещенск (4162)22-76-07  
Брянск (4832)59-03-52  
Владивосток (423)249-28-31  
Владикавказ (8672)28-90-48  
Владимир (4922)49-43-18  
Волгоград (844)278-03-48  
Вологда (8172)26-4159  
Воронеж (473)204-51-73  
Екатеринбург (343)384-55-89  
Иваново (4932)77-34-06  
Ижевск (3412)26-03-58  
Иркутск (395)279-98-46  
Казань (843)206-01-48

Калининград (4012)72-03-81  
Калуга (4842)92-23-67  
Кемерово (3842)65-04-62  
Киров (8332)68-02-04  
Коломна (4966)23-41-49  
Кострома (4942)77-07-48  
Краснодар (861)203-40-90  
Красноярск (391)204-63-61  
Курск (4712)77-13-04  
Курган (3522)50-90-47  
Липецк (4742)52-20-81  
Магнитогорск (3519)55-03-13  
Москва (495)268-04-70  
Мурманск (8152)59-64-93  
Набережные Челны (8552)20-53-41  
Нижний Новгород (831)429-08-12  
Новокузнецк (3843)20-46-81  
Ноябрьск (3496)41-32-12  
Новосибирск (383)227-86-73

Омск (3812)21-46-40  
Орел (4862)44-53-42  
Оренбург (3532)37-68-04  
Пенза (8412)22-31-16  
Петрозаводск (8142)55-98-37  
Псков (8112)59-10-37  
Пермь (342)205-81-47  
Ростов-на-Дону (863)308-18-15  
Рязань (4912)46-61-64  
Самара (846)206-03-16  
Саранск (8342)22-96-24  
Санкт-Петербург (812)309-46-40  
Саратов (845)249-38-78  
Севастополь (8692)22-31-93  
Симферополь (3652)67-13-56  
Смоленск (4812)29-41-54  
Сочи (862)225-72-31  
Ставрополь (8652)20-65-13  
Сургут (3462)77-98-35

Сыктывкар (8212)25-95-17  
Тамбов (4752)50-40-97  
Тверь (4822)63-31-35  
Тольятти (8482)63-91-07  
Томск (3822)98-41-53  
Тула (4872)33-79-87  
Тюмень (3452)66-21-18  
Ульяновск (8422)24-23-59  
Улан-Удэ (3012)59-97-51  
Уфа (347)229-48-12  
Хабаровск (4212)92-98-04  
Чебоксары (8352)28-53-07  
Челябинск (351)202-03-61  
Череповец (8202)49-02-64  
Чита (3022)38-34-83  
Якутск (4112)23-90-97  
Ярославль (4852)69-52-93

Россия +7(495)268-04-70

Казахстан +7(7172)727-132

Киргизия +996(312)96-26-47

Адрес: <https://fast.nt-rt.ru/> || эл.почта: [ftj@nt-rt.ru](mailto:ftj@nt-rt.ru)