

## ТЕХ. ХАРАКТЕРИСТИКИ

По вопросам продаж и поддержки обращайтесь:

Алматы (7273)495-231  
Ангарск (3955)60-70-56  
Архангельск (8182)63-90-72  
Астрахань (8512)99-46-04  
Барнаул (3852)73-04-60  
Белгород (4722)40-23-64  
Благовещенск (4162)22-76-07  
Брянск (4832)59-03-52  
Владивосток (423)249-28-31  
Владикавказ (8672)28-90-48  
Владимир (4922)49-43-18  
Волгоград (844)278-03-48  
Вологда (8172)26-4159  
Воронеж (473)204-51-73  
Екатеринбург (343)384-55-89  
Иваново (4932)77-34-06  
Ижевск (3412)26-03-58  
Иркутск (395)279-98-46  
Казань (843)206-01-48

Калининград (4012)72-03-81  
Калуга (4842)92-23-67  
Кемерово (3842)65-04-62  
Киров (8332)68-02-04  
Коломна (4966)23-41-49  
Кострома (4942)77-07-48  
Краснодар (861)203-40-90  
Красноярск (391)204-63-61  
Курск (4712)77-13-04  
Курган (3522)50-90-47  
Липецк (4742)52-20-81  
Магнитогорск (3519)55-03-13  
Москва (495)268-04-70  
Мурманск (8152)59-64-93  
Набережные Челны (8552)20-53-41  
Нижний Новгород (831)429-08-12  
Новокузнецк (3843)20-46-81  
Ноябрьск (3496)41-32-12  
Новосибирск (383)227-86-73

Омск (3812)21-46-40  
Орел (4862)44-53-42  
Оренбург (3532)37-68-04  
Пенза (8412)22-31-16  
Петрозаводск (8142)55-98-37  
Псков (8112)59-10-37  
Пермь (342)205-81-47  
Ростов-на-Дону (863)308-18-15  
Рязань (4912)46-61-64  
Самара (846)206-03-16  
Саранск (8342)22-96-24  
Санкт-Петербург (812)309-46-40  
Саратов (845)249-38-78  
Севастополь (8692)22-31-93  
Симферополь (3652)67-13-56  
Смоленск (4812)29-41-54  
Сочи (862)225-72-31  
Ставрополь (8652)20-65-13  
Сургут (3462)77-98-35

Сыктывкар (8212)25-95-17  
Тамбов (4752)50-40-97  
Тверь (4822)63-31-35  
Тольятти (8482)63-91-07  
Томск (3822)98-41-53  
Тула (4872)33-79-87  
Тюмень (3452)66-21-18  
Ульяновск (8422)24-23-59  
Улан-Удэ (3012)59-97-51  
Уфа (347)229-48-12  
Хабаровск (4212)92-98-04  
Чебоксары (8352)28-53-07  
Челябинск (351)202-03-61  
Череповец (8202)49-02-64  
Чита (3022)38-34-83  
Якутск (4112)23-90-97  
Ярославль (4852)69-52-93

Россия +7(495)268-04-70

Казахстан +7(7172)727-132

Киргизия +996(312)96-26-47

Адрес: <https://fast.nt-rt.ru/> || эл.почта: [ftj@nt-rt.ru](mailto:ftj@nt-rt.ru)

# WILD

# 69T2

RV.2-1-2024

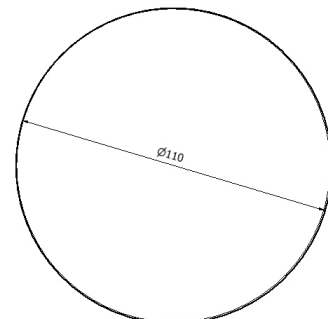
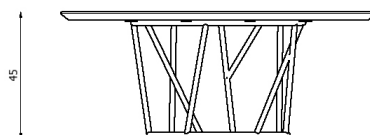
**Descrizione / Description****Misure / Quotes****Caratteristiche / Characteristics**

Tavolo basso tondo in alluminio verniciato / Round low table in painted aluminium

Design / Design	Robby Cantarutti & Partners   2019
Dimensioni / Dimensions	Ø 110 x 45 h
Esterno / Outdoor	Si / Yes
Struttura / Structure	Alluminio estruso / Extruded aluminium
Piedini / Caps	Polipropilene ed elastomero termoplastico / Polypropylene and thermoplastics elastomer
Finitura / Paint finishes	Verniciatura polveri poliestere o poliuretaniche / Paint finish with polyester or polyurethane powders
Impilabilità / Stackability	No
Viterie assemblaggio / Assembly screws	Acciaio inox / Stainless steel
Peso netto singolo pezzo / Net weight	15 kg
Pezzi per scatola / Units per package	1 assemblato / 1 assembled
Dimensione e volume imballo / Packaging dimension and volume	131 x 131 x 45 cm 0.772 m <sup>3</sup>
Peso lordo imballo / Packaging Brutto weight	31 kg
Garanzia / Quality guarantee	2 anni / 2 years

# WILD

# 69T2S

RV.2-1-2024

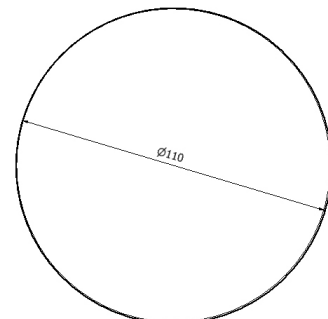
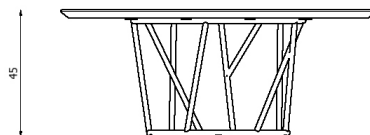
**Descrizione / Description****Misure / Quotes****Caratteristiche / Characteristics**

Tavolo basso tondo in alluminio verniciato con piano in alluminio puntinato / Round low table in painted aluminium with top in speckled aluminium

Design / Design	Robby Cantarutti & Partners   2019
Dimensioni / Dimensions	Ø 110 x 45 h
Esterno / Outdoor	Si / Yes
Struttura / Structure	Alluminio estruso / Extruded aluminium
Piedini / Caps	Polipropilene ed elastomero termoplastico / Polypropylene and thermoplastics elastomer
Finitura / Paint finishes	Verniciatura polveri poliestere o poliuretaniche ed effetto puntinato / Paint finish with polyester or polyurethane powders and speckled aluminium effect
Impilabilità / Stackability	No
Viterie assemblaggio / Assembly screws	Acciaio inox / Stainless steel
Peso netto singolo pezzo / Net weight	15 kg
Pezzi per scatola / Units per package	1 assemblato / 1 assembled
Dimensione e volume imballo / Packaging dimension and volume	131 x 131 x 45 cm 0.772 m <sup>3</sup>
Peso lordo imballo / Packaging Brutto weight	31 kg
Garanzia / Quality guarantee	2 anni / 2 years

# WILD

# 69T5

RV.2-1-2024

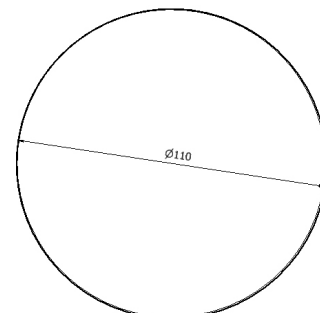
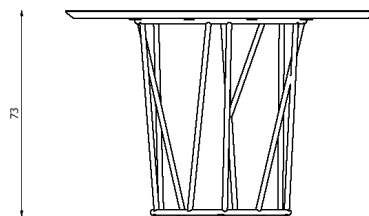
**Descrizione / Description****Misure / Quotes****Caratteristiche / Characteristics**

Tavolo tondo in alluminio verniciato / Round table in painted aluminium

Design / Design	Robby Cantarutti & Partners   2019
Dimensioni / Dimensions	Ø 110 x 73 h
Esterno / Outdoor	Si / Yes
Struttura / Structure	Alluminio estruso / Extruded aluminium
Piedini / Caps	Polipropilene ed elastomero termoplastico / Polypropylene and thermoplastics elastomer
Finitura / Paint finishes	Verniciatura polveri poliestere o poliuretaniche / Paint finish with polyester or polyurethane powders
Impilabilità / Stackability	No
Viterie assemblaggio / Assembly screws	Acciaio inox / Stainless steel
Peso netto singolo pezzo / Net weight	16 kg
Pezzi per scatola / Units per package	1 assemblato / 1 assembled
Dimensione e volume imballo / Packaging dimension and volume	131 x 131 x 77 cm 1,321 m <sup>3</sup>
Peso lordo imballo / Packaging Brutto weight	33 kg
Garanzia / Quality guarantee	2 anni / 2 years

# WILD

# 69T5S

RV.2-1-2024

Descrizione / Description

Misure / Quotes

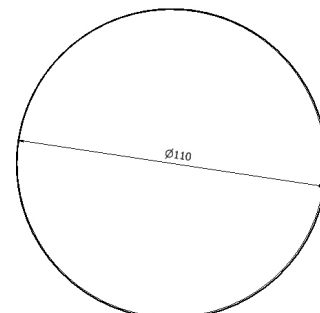
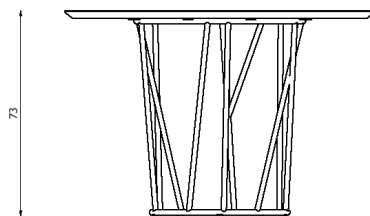

## Caratteristiche / Characteristics

Tavolo tondo in alluminio verniciato con piano in alluminio puntinato / Round table in painted aluminium with top in speckled aluminium

Design / Design	Robby Cantarutti & Partners   2019
Dimensioni / Dimensions	Ø 110 x 73 h
Esterno / Outdoor	Si / Yes
Struttura / Structure	Alluminio estruso / Extruded aluminium
Piedini / Caps	Polipropilene ed elastomero termoplastico / Polypropylene and thermoplastics elastomer
Finitura / Paint finishes	Verniciatura polveri poliestere o poliuretaniche ed effetto puntinato / Paint finish with polyester or polyurethane powders and speckled aluminium effect
Impilabilità / Stackability	No
Viterie assemblaggio / Assembly screws	Acciaio inox / Stainless steel
Peso netto singolo pezzo / Net weight	16 kg
Pezzi per scatola / Units per package	1 assemblato / 1 assembled
Dimensione e volume imballo / Packaging dimension and volume	131 x 131 x 77 cm 1,321 m <sup>3</sup>
Peso lordo imballo / Packaging Brutto weight	33 kg
Garanzia / Quality guarantee	2 anni / 2 years

# WILD

# 69T8G

RV.2-1-2024

Descrizione / Description

Misure / Quotes

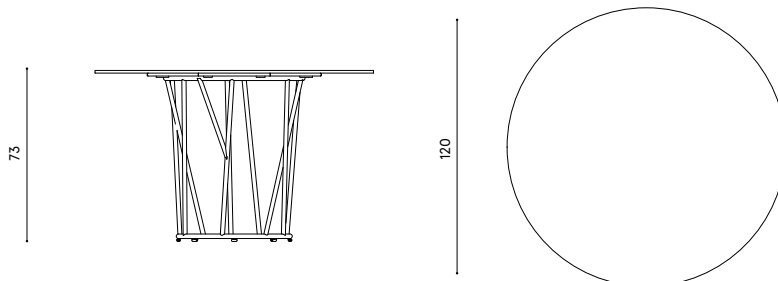
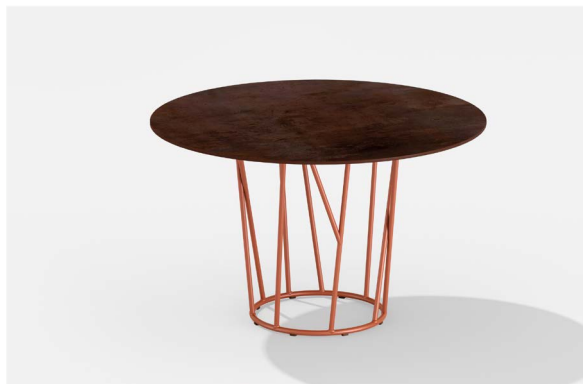

Caratteristiche / Characteristics

Tavolo tondo in alluminio verniciato con piano in gres porcellanato (sp. 12 mm) / Round table in painted aluminium with top in porcelain stoneware (th. mm 12)

Design / Design	Robby Cantarutti & Partners   2023
Dimensioni / Dimensions	Ø 120 x 73 h
Esterno / Outdoor	Si / Yes
Struttura / Structure	Alluminio estruso e gres porcellanato / Extruded aluminium and porcelain stoneware
Piedini / Caps	Polipropilene ed elastomero termoplastico / Polypropylene and thermoplastics elastomer
Finitura / Paint finishes	Verniciatura polveri poliestere o poliuretaniche / Paint finish with polyester or polyurethane powders
Impilabilità / Stackability	No
Viterie assemblaggio / Assembly screws	Acciaio inox / Stainless steel
Peso netto singolo pezzo / Net weight	39 kg
Pezzi per scatola / Units per package	1 assemblato / 1 assembled
Dimensione e volume imballo / Packaging dimension and volume	131 x 131 x 77 cm 1,321 m <sup>3</sup>
Peso lordo imballo / Packaging Brutto weight	51 kg
Garanzia / Quality guarantee	2 anni / 2 years

# WILD

# 69T6

RV.2-1-2024

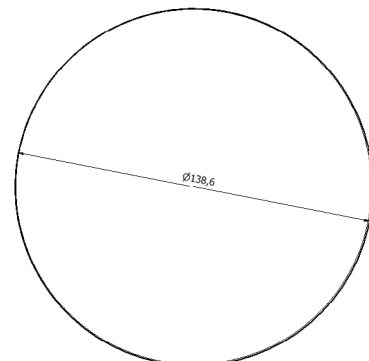
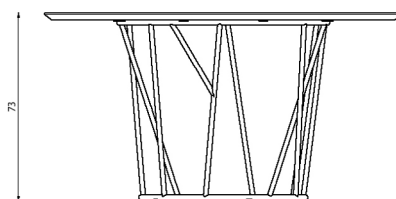
**Descrizione / Description****Misure / Quotes****Caratteristiche / Characteristics**

Tavolo tondo in alluminio verniciato / Round table in painted aluminium

Design / Design	Robby Cantarutti & Partners   2019
Dimensioni / Dimensions	Ø 138 x 73 h
Esterno / Outdoor	Si / Yes
Struttura / Structure	Alluminio estruso / Extruded aluminium
Piedini / Caps	Polipropilene ed elastomero termoplastico / Polypropylene and thermoplastics elastomer
Finitura / Paint finishes	Verniciatura polveri poliestere o poliuretaniche / Paint finish with polyester or polyurethane powders
Impilabilità / Stackability	No
Viterie assemblaggio / Assembly screws	Acciaio inox / Stainless steel
Peso netto singolo pezzo / Net weight	22,5 kg
Pezzi per scatola / Units per package	1 assemblato / 1 assembled
Dimensione e volume imballo / Packaging dimension and volume	148 x 148 x 82 cm 1,796 m <sup>3</sup>
Peso lordo imballo / Packaging Brutto weight	40 kg
Garanzia / Quality guarantee	2 anni / 2 years

# WILD

# 69T6S

RV.2-1-2024

Descrizione / Description

Misure / Quotes

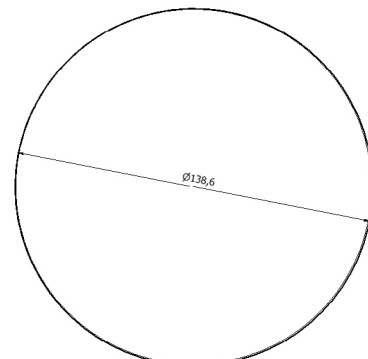
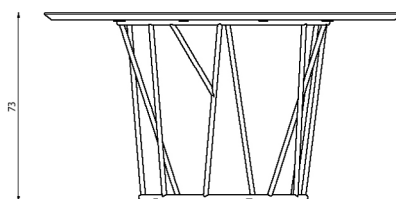

## Caratteristiche / Characteristics

Tavolo tondo in alluminio verniciato con piano in alluminio puntinato / Round table in painted aluminium with top in speckled aluminium

Design / Design	Robby Cantarutti & Partners   2019
Dimensioni / Dimensions	Ø 138 x 73 h
Esterno / Outdoor	Si / Yes
Struttura / Structure	Alluminio estruso / Extruded aluminium
Piedini / Caps	Polipropilene ed elastomero termoplastico / Polypropylene and thermoplastics elastomer
Finitura / Paint finishes	Verniciatura polveri poliestere o poliuretaniche ed effetto puntinato / Paint finish with polyester or polyurethane powders and speckled aluminium effect
Impilabilità / Stackability	No
Viterie assemblaggio / Assembly screws	Acciaio inox / Stainless steel
Peso netto singolo pezzo / Net weight	22,5 kg
Pezzi per scatola / Units per package	1 assemblato / 1 assembled
Dimensione e volume imballo / Packaging dimension and volume	148 x 148 x 82 cm 1,796 m <sup>3</sup>
Peso lordo imballo / Packaging Brutto weight	40 kg
Garanzia / Quality guarantee	2 anni / 2 years



# WILD

# 69T9G

RV.2-1-2024

Descrizione / Description

Misure / Quotes

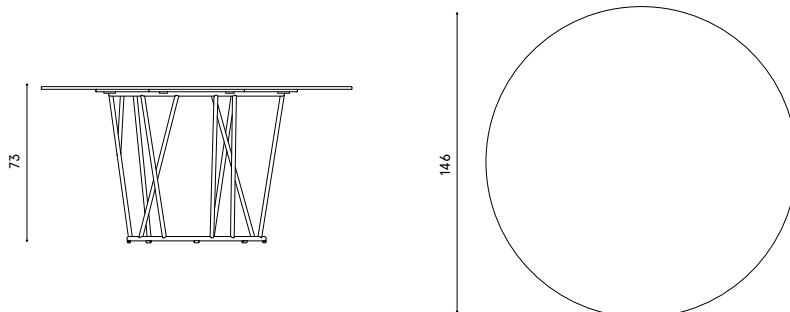

## Caratteristiche / Characteristics

Tavolo tondo in alluminio verniciato con piano in gres porcellanato (sp. 12 mm) / Round table in painted aluminium with top in porcelain stoneware (th. mm 12)

Design / Design	Robby Cantarutti & Partners   2019
Dimensioni / Dimensions	Ø 146 x 73 h
Esterno / Outdoor	Si / Yes
Struttura / Structure	Alluminio estruso e gres porcellanato / Extruded aluminium and porcelain stoneware
Piedini / Caps	Polipropilene ed elastomero termoplastico / Polypropylene and thermoplastics elastomer
Finitura / Paint finishes	Verniciatura polveri poliestere o poliuretaniche / Paint finish with polyester or polyurethane powders
Impilabilità / Stackability	No
Viterie assemblaggio / Assembly screws	Acciaio inox / Stainless steel
Peso netto singolo pezzo / Net weight	56 kg
Pezzi per scatola / Units per package	1 assemblato / 1 assembled
Dimensione e volume imballo / Packaging dimension and volume	148 x 148 x 82 cm 1,796 m <sup>3</sup>
Peso lordo imballo / Packaging Brutto weight	69 kg
Garanzia / Quality guarantee	2 anni / 2 years

# WILD

# 69T7

RV.2-1-2024

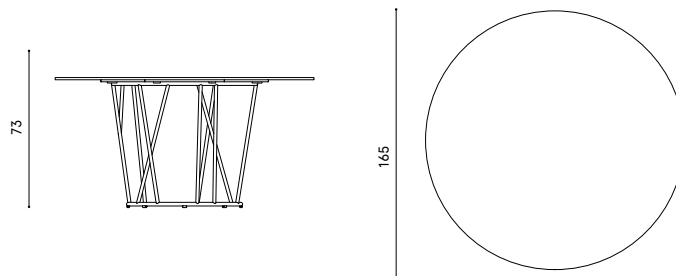
**Descrizione / Description****Misure / Quotes****Caratteristiche / Characteristics**

Tavolo tondo in alluminio verniciato / Round table in painted aluminium

Design / Design	Robby Cantarutti & Partners   2019
Dimensioni / Dimensions	Ø 165 x 73 h
Esterno / Outdoor	Si / Yes
Struttura / Structure	Alluminio estruso / Extruded aluminium
Piedini / Caps	Polipropilene ed elastomero termoplastico / Polypropylene and thermoplastics elastomer
Finitura / Paint finishes	Verniciatura polveri poliestere o poliuretaniche / Paint finish with polyester or polyurethane powders
Impilabilità / Stackability	No
Viterie assemblaggio / Assembly screws	Acciaio inox / Stainless steel
Peso netto singolo pezzo / Net weight	22,5 kg
Pezzi per scatola / Units per package	1 assemblato / 1 assembled
Dimensione e volume imballo / Packaging dimension and volume	148 x 148 x 82 cm 1,796 m <sup>3</sup>
Peso lordo imballo / Packaging Brutto weight	40 kg
Garanzia / Quality guarantee	2 anni / 2 years

# WILD

# 69T7S

RV.2-1-2024

Descrizione / Description

Misure / Quotes

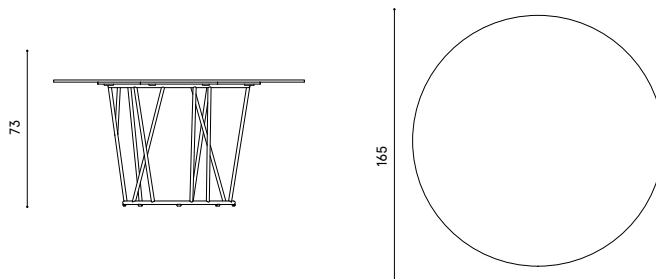

## Caratteristiche / Characteristics

Tavolo tondo in alluminio verniciato con piano in alluminio puntinato / Round table in painted aluminium with top in speckled aluminium

Design / Design	Robby Cantarutti & Partners   2019
Dimensioni / Dimensions	Ø 165 x 73 h
Esterno / Outdoor	Si / Yes
Struttura / Structure	Alluminio estruso / Extruded aluminium
Piedini / Caps	Polipropilene ed elastomero termoplastico / Polypropylene and thermoplastics elastomer
Finitura / Paint finishes	Verniciatura polveri poliestere o poliuretaniche ed effetto puntinato / Paint finish with polyester or polyurethane powders and speckled aluminium effect
Impilabilità / Stackability	No
Viterie assemblaggio / Assembly screws	Acciaio inox / Stainless steel
Peso netto singolo pezzo / Net weight	22,5 kg
Pezzi per scatola / Units per package	1 assemblato / 1 assembled
Dimensione e volume imballo / Packaging dimension and volume	148 x 148 x 82 cm 1,796 m <sup>3</sup>
Peso lordo imballo / Packaging Brutto weight	40 kg
Garanzia / Quality guarantee	2 anni / 2 years

## По вопросам продаж и поддержки обращайтесь:

Алматы (7273)495-231  
Ангарск (3955)60-70-56  
Архангельск (8182)63-90-72  
Астрахань (8512)99-46-04  
Барнаул (3852)73-04-60  
Белгород (4722)40-23-64  
Благовещенск (4162)22-76-07  
Брянск (4832)59-03-52  
Владивосток (423)249-28-31  
Владикавказ (8672)28-90-48  
Владимир (4922)49-43-18  
Волгоград (844)278-03-48  
Вологда (8172)26-4159  
Воронеж (473)204-51-73  
Екатеринбург (343)384-55-89  
Иваново (4932)77-34-06  
Ижевск (3412)26-03-58  
Иркутск (395)279-98-46  
Казань (843)206-01-48

Калининград (4012)72-03-81  
Калуга (4842)92-23-67  
Кемерово (3842)65-04-62  
Киров (8332)68-02-04  
Коломна (4966)23-41-49  
Кострома (4942)77-07-48  
Краснодар (861)203-40-90  
Красноярск (391)204-63-61  
Курск (4712)77-13-04  
Курган (3522)50-90-47  
Липецк (4742)52-20-81  
Магнитогорск (3519)55-03-13  
Москва (495)268-04-70  
Мурманск (8152)59-64-93  
Набережные Челны (8552)20-53-41  
Нижний Новгород (831)429-08-12  
Новокузнецк (3843)20-46-81  
Ноябрьск (3496)41-32-12  
Новосибирск (383)227-86-73

Омск (3812)21-46-40  
Орел (4862)44-53-42  
Оренбург (3532)37-68-04  
Пенза (8412)22-31-16  
Петрозаводск (8142)55-98-37  
Псков (8112)59-10-37  
Пермь (342)205-81-47  
Ростов-на-Дону (863)308-18-15  
Рязань (4912)46-61-64  
Самара (846)206-03-16  
Саранск (8342)22-96-24  
Санкт-Петербург (812)309-46-40  
Саратов (845)249-38-78  
Севастополь (8692)22-31-93  
Симферополь (3652)67-13-56  
Смоленск (4812)29-41-54  
Сочи (862)225-72-31  
Ставрополь (8652)20-65-13  
Сургут (3462)77-98-35

Сыктывкар (8212)25-95-17  
Тамбов (4752)50-40-97  
Тверь (4822)63-31-35  
Тольятти (8482)63-91-07  
Томск (3822)98-41-53  
Тула (4872)33-79-87  
Тюмень (3452)66-21-18  
Ульяновск (8422)24-23-59  
Улан-Удэ (3012)59-97-51  
Уфа (347)229-48-12  
Хабаровск (4212)92-98-04  
Чебоксары (8352)28-53-07  
Челябинск (351)202-03-61  
Череповец (8202)49-02-64  
Чита (3022)38-34-83  
Якутск (4112)23-90-97  
Ярославль (4852)69-52-93

Россия +7(495)268-04-70

Казахстан +7(7172)727-132

Киргизия +996(312)96-26-47

Адрес: <https://fast.nt-rt.ru/> || эл.почта: [ftj@nt-rt.ru](mailto:ftj@nt-rt.ru)